

Snow Melting on Roofs by Sprinkling Ground Water

By

Masao HIGASHIURA*

*Shinjo Branch, National Research Center for Disaster Prevention
No. 1400, Takadan, Toka-machi, Shinjo, Yamagata-ken 996*

Abstract

In snowy urban areas of Japan, the use of ground water is effective for snow melting and devices for sprinkling ground water through pipes are not expensive, except for the initial cost equipment. Therefore, this method of snow melting has spread rapidly and it has come to be widely used on roads, parking places, roofs of factories and greenhouses in the regions where ground water is abundant.

The snow-melting efficiency of ground water is remarkably affected by the meteorological conditions such as air temperature and wind velocity in the area. The author examined the heat efficiency of snow melting on the roof using two kinds of small experimental houses in a field experiment and a small experimental house in a cold room experiment.

Relations between the lowering of sprinkled water temperature on the roof and flowing distance were obtained for representative meteorological conditions. By use of the relation, the amount of snow to be melted by sprinkling ground water was calculated. The amount of snow, S (mm/hour, equivalent to water depth) was expressed by the following equation:

$$S = 6wT_e / [(80 - 0.5T) \times 10^2]$$

where w is flow rate of sprinkled water (cc/min·m²), T_e terminal water temperature (°C) and T snow temperature (°C, equal to air temperature). The terminal water temperature T_e will be obtained by Fig. 6 or Fig. 7.

I. Introduction

The ground water of 10 to 15°C in winter is very effective for snow melting. The first hint of this effectiveness came from snow melting which occurred near leaking wells. Devices for sprinkling ground water through pipes were soon used on roads. They are called "Shosetsu-paipu system" in Japanese. This method of snow melting has proved effective. Snow is instantly melted away by a moderate sprinkled amount of ground water.

The method of snow melting by ground water has come into wide use in the snowy regions because it can be easily used as the heat source for snow melting. In practice, the amount of ground water to sprinkle on the road is determined by the process of trial and error. The heat energy of ground water to be used for snow melting depends remarkably on the meteorological conditions such as air temperature and wind velocity in the area. To determine the efficiency in such conditions on roads, several investigations have been made by H. Saito (1967) and H. Nakamura (1970).

* Snow Disaster Laboratory

In the built-up areas of snowy cities, until recent time, the removed snow cover on the roofs used to be deposited onto the roads. But owing to the rapid progress of the motorization, it has become a serious problem to dispose of the snow on the roofs. Several reports of researches for roofs deal with the problem of snow melting (Furukawa, 1966 and Saito, 1967), but the heat efficiency of snow melting by ground water has not been obtained experimentally in outdoors. As each region has naturally its own potential amount of ground water (Yuhara, 1972), therefore it is important to determine the heat efficiency of ground water to melt snow, so as to avoid useless sprinkling of ground water on the roofs.

In this paper an experimental study of snow melting on the roof is described. It aimed at finding the difference of snow-melting efficiency on the roof in relation to meteorological conditions. It was made at the Shinjo Branch, National Research Center for Disaster Prevention.

II. Field Experiments and results

1) Lowering of water temperature on the roof

Two kinds of small experimental houses with pipes (made of vinylchloride, 20 mm in diameter), flow meters and equipments to measure temperature were used (Phot. 1 and Table 1).

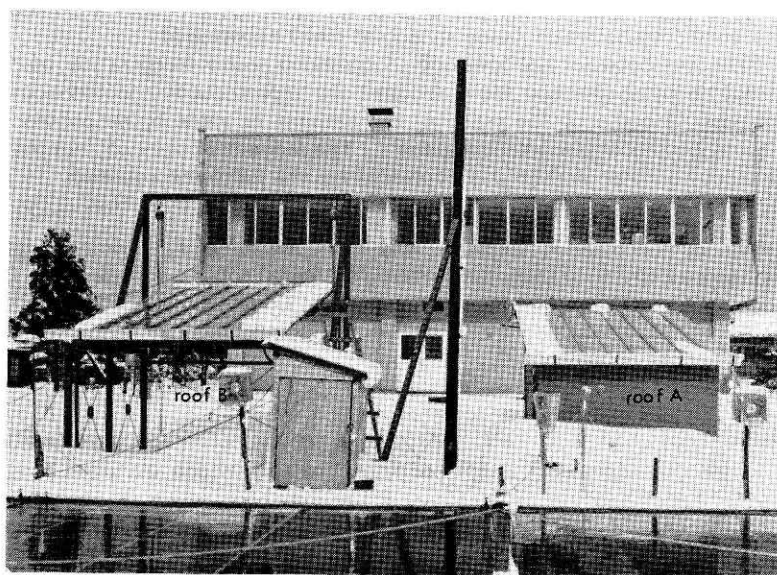

Phot. 1 Experimental roofs for snow melting.

Table 1. Experimental roofs.

roof	A	B
pitch	2/10(11°8')	0~5/10(26°38')
area	15 m ² (5 m × 3 m)	16.5 m ² (5.5 m × 3 m)
material	enameled zinc (zinc coating with paint)	enameled zinc (zinc coating with paint)
remarks	a wooden house with wall	a house made of steel, without wall

Water was sprinkled by each nozzle (3 mm ϕ) in the pipe (20 mm ϕ), where the nozzle was made at intervals of 35 cm (corresponds to each span of a roof) and the pipe is fixed at the ridge of the roofs. As the sprinkled water flows down onto the roof surface until it enters the eave trough at the eaves, the water temperature is lowered. The difference of the temperature between the ridge and the eaves of the roof, was measured in this experiment. On the roof-A, at the flow rate of 0.45 l/min·m² water was sprinkled and on the roof-B of fixed pitch of 2/10 (11°8'), the flow rate of sprinkled water was 0.90 l/min·m². The experiment was done in the period from 16 January to 2 March, 1971.

The lowering of water temperature on the roof is considered to be caused by the amount of water, air temperature and wind velocity. Therefore, the relation among them were examined. Although the measurement for obtaining the relation was done continuously in the whole period, only the data obtained at night (5 : 00 p.m. to 7 : 00 a.m.) were analyzed to reduce the effect of solar radiation, where mean value of water temperature, air temperature and wind velocity in thirty minutes were used.

In Fig. 1 is shown the relation between the difference of water temperature at the ridge of the roof and the eaves, and air temperature, at the condition of wind velocity of 3 m/s and flow rate of sprinkled water of 0.45 l/min·m² on the roof-A. Sprinkled water temperature was about 10°C at the ridge (The solid line in Fig. 1 shows the average.). A similar relation at wind velocity of 3 m/s and flow rate of sprinkled water of 0.90 l/min·m² on the roof-B is shown in Fig. 2. Here the broken line shows the average of the observed values. Comparing the roof-A with the roof-B, on the lowering of the water temperature, it seems that the lowering of water temperature on the

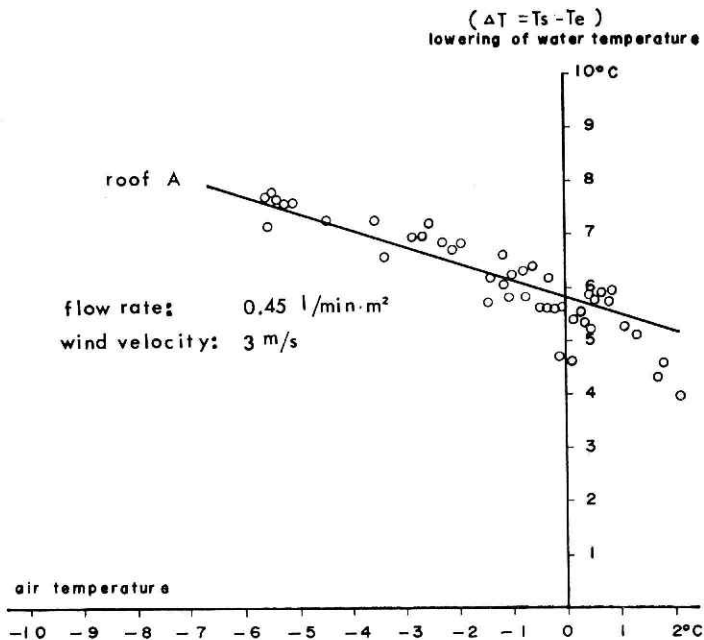

Fig. 1 Relation between lowering of water temperature ($\Delta T = T_s - T_e$) and air temperature. T_s and T_e are water temperatures at sprinkling point (10°C) and at terminus, 5 m apart from it, respectively.

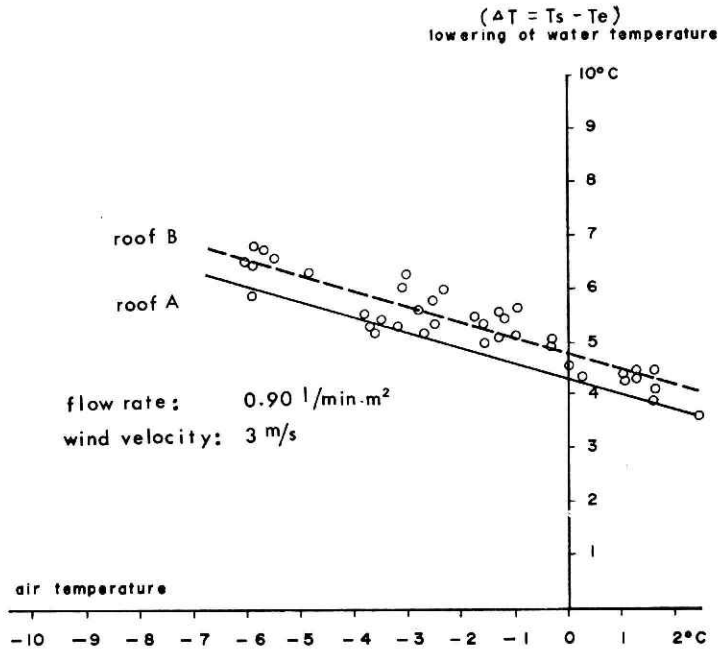

Fig. 2 Relation between lowering of water temperature ($\Delta T = T_s - T_e$) and air temperature. T_s and T_e are water temperatures at sprinkling point (10°C) and at terminus, 5 m apart from it, respectively.

roof-A is much larger, due to the difference of the sprinkled water amount. However, the roof-A has a wall and the roof-B does not. To know, therefore, the effect of the existence of wall, the same amount of water of $0.90 \text{ l/min}\cdot\text{m}^2$ was sprinkled on the roof-A in the next winter. The result obtained was that the lowering of the water temperature on the roof-B is 0.5°C larger than on the roof-A. The solid line in Fig. 2 is equal to the lowering of water temperature at the roof-A.

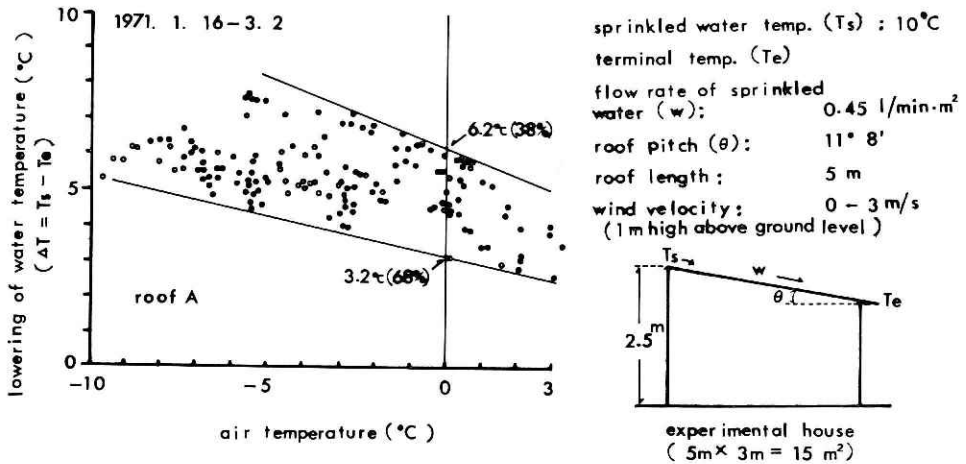

Fig. 3 Lowering of water temperature for snow melting on the roof-A.

All the data of flow rate of sprinkled water of $0.45 \text{ l/min}\cdot\text{m}^2$ at the wind velocity range of 0 to 3 m/s were plotted (Fig. 3). According to this figure at the air temperature of 0°C , the heat efficiency of snow melting on this roof became 68 percent in windless time and 38 percent in the wind velocity of 3 m/s. It is obvious that the lowering of the sprinkled water temperature becomes larger as the wind velocity increases.

2) Velocity of sprinkled water on the roof

Using the roof-B, flowing behavior of sprinkled water on the roof was observed for five meters flowing and the time required for 5 m distant flow of the sprinkled water was measured using ink as a marker and then the mean water velocity was calculated.

The water was sprinkled to each span ($32 \text{ cm} \times 9 \text{ spans} \times 5 \text{ m}$) of the roof through each nozzle $3 \text{ mm}\phi$ of the pipe. The relation between mean water velocity and roof pitch is shown in Fig. 4. At flow rate of $0.45 \text{ l/min}\cdot\text{m}^2$ and roof pitch of 2/10 to 3/10, water velocity was in the range of 0.7 to 1.0 m/s and at flow rate of $0.90 \text{ l/min}\cdot\text{m}^2$ and roof pitch of 2/10 to 3/10, water velocity was in that of 0.9 to 1.2 m/s. It was observed that running water did not flow on the whole roof surface evenly when both the flow rate and roof pitch were small.

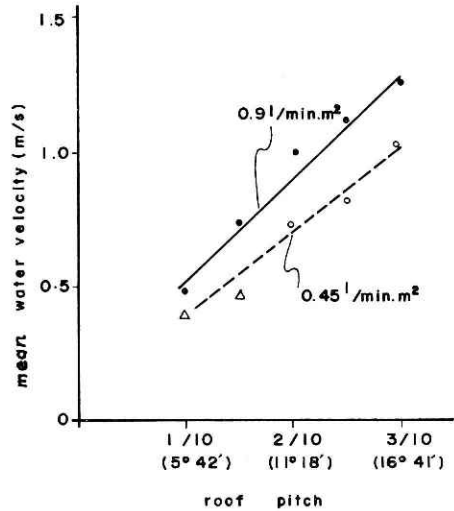
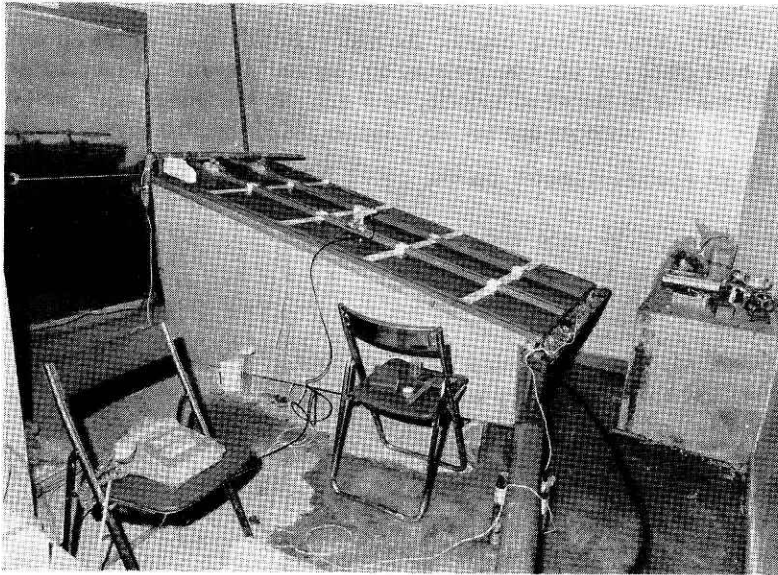

Fig. 4 Velocity of running water at a point of 5 m distant from sprinkling point on the roof. Δ : water did not flow on the whole surface of the roof evenly.

III. Cold room experiment and results

Some factors were not changeable in the outdoor experiment. So an indoor experiment was done in a cold room (Phot. 2). In this experiment a small experimental house, a water temperature regulator, an apparatus to measure temperature and an anemometer were used (Fig. 5). The experimental condition of this house is the same as the roof-A. The walls were made of veneer board with a thermal insulation board and the roof of enameled zinc was $105 \times 230 \text{ cm}^2$ in area.

Though the experiment in the cold room followed the same method as the field experiment, the volume of sprinkled water, water temperature, wind velocity and roof pitch were changeable (Fig. 5). The sprinkling procedure was as follows: To keep constant water flow, a water pump, P_1 was used, and at the same time, the volume of the water reservoir was kept constant as shown in the right hand of Fig. 5 and to obtain the lower water temperature than 20°C , a water temperature regulator was used as shown in the middle part of Fig. 5. So as to get any water temperature, a bulb of the regulator was adjusted manually. Then the water of a fixed temperature was sent to the experimental roof surface by a second pump (P_2) where a given flow rate of water sprinkled from nozzles $3 \text{ mm}\phi$ of the pipe $20 \text{ mm}\phi$. The sprinkled water temperature, the terminal temperature and the room temperature were measured by



Phot. 2 Experimental equipment in a cold room.

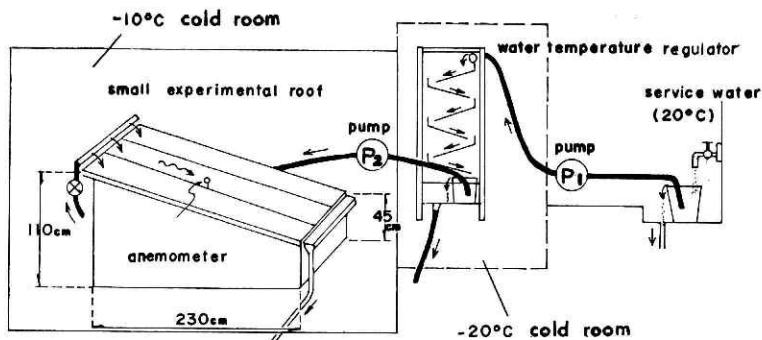

Fig. 5 Schematic diagram of experimental setup in a cold room

the copper-constantan thermocouple and recorded. Wind velocity is controlled by an electric fan and a cooler of the cold room. The wind velocity is measured by a thermoelectric wind gauge which is fixed on the roof.

To compare the results of a field and a cold room experiment in a same condition, the same wind velocity was used. The wind velocity of 3.2 m/s at the roof-A surface of 2 m high above the ground was deduced by the following equation by the aid of the measured wind velocity of 1 m high above the ground. When the wind blows steadily, the vertical distribution of the wind velocity is given by (M.A.F.P.B., 1961),

$$U_z = (V_*/K) \ln (Z/Z_0) = 5.75 V_* \log (Z/Z_0)$$

U_z : wind velocity (cm/s) at the height of Z (cm)

V_* : friction velocity (cm/s)

K : Karman constant (0.4)

Z_0 : roughness length (cm)

The value of the roughness is adopted as 0.005 cm (M.A.F.P.B., 1961) on the snow surface.

The experiment in the cold room was done under the following conditions; flow rate of sprinkled water: $0.45 \text{ l/min}\cdot\text{m}^2$, $0.90 \text{ l/min}\cdot\text{m}^2$, wind velocity: 0.5 m/s , 3.2 m/s , air temperature (room): 0°C , -5°C , -10°C , roof pitch: $2/10$ ($11^\circ 8'$), $3/10$ ($26^\circ 33'$). The effect of each item upon the total effect was investigated and 24 different experiments were done. In the case of the wind velocity over 3.2 m/s , no experiments were done, because it was observed that the wind velocity over $4\sim 5 \text{ m/s}$ blows off snow flakes from the roof surface.

A relation showing the lowering of water temperature between the sprinkled point (ridge of the roof) and the terminus (cave trough) was shown in Fig. 6, where the roof pitch was $2/10$, flow rate $0.45 \text{ l/min}\cdot\text{m}^2$ and wind velocity 3.2 m/s . For example, sprinkled water of 10°C was cooled down to 6°C for 1.7 m flow down in the atmosphere of -5°C . In the case of $0.90 \text{ l/min}\cdot\text{m}^2$, a similar relation was obtained as shown in Fig. 7. As for the result obtained from the roof pitch difference between $2/10$ and $3/10$, it was difficult to discriminate the difference of their heat loss in this

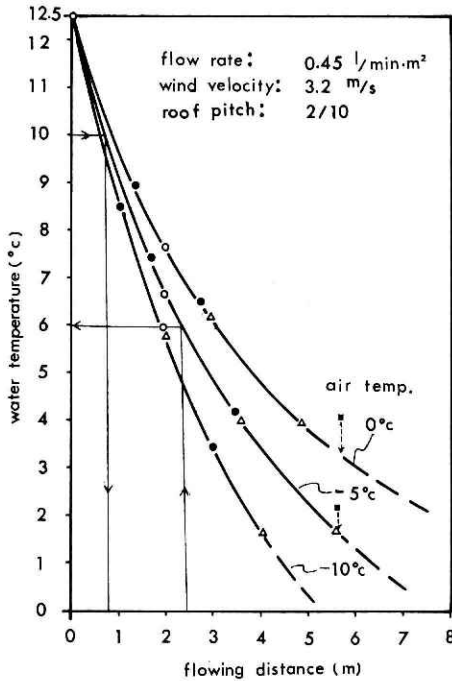

Fig. 6 Relation between water temperature and flowing distance in the cold room experiment. Water temperature was obtained at sprinkling point and a point 2 m distant from sprinkling point on the roof. Each pair of the same marks corresponds to each experiment. Small full squares show the results of field experiment.

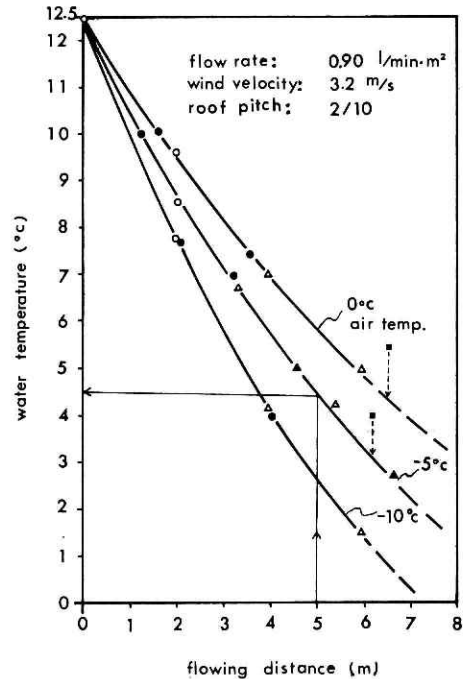

Fig. 7 Relation between water temperature and flowing distance in the cold room experiment. Water temperature was obtained at sprinkling point and a point 2 m distant from sprinkling point on the roof. Each pair of the same marks corresponds to each experiment. Small full squares show the results of field experiment.

experiment.

As shown in Fig. 6 and Fig. 7, after 5 m flow down on the roof, the terminal water temperature of the sprinkled water of 10°C in a cold room experiment showed about 0.5°C (Fig. 6) and about 1°C (Fig. 7) lower than the value in the filed experiment, respectively.

IV. Estimation of the snowfall to be melted by the sprinkled water

When the terminal temperature of ground water sprinkled on the roof becomes T_e °C, the potential heat quantity equivalent to $(T_e - 0)$ °C will be used for snow melting.

The heat quantity, Q_1 (cal/min) required to melt snow on the roof of 5×1 m² per minute in the snowfall intensity of S (mm/hour, snow temperature is T °C) is given by (Fig. 8)

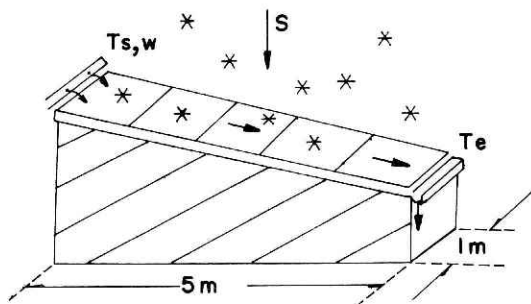

Fig. 8 Model to calculate the heat quantity to melt snow on the roof by ground water. S : snowfall intensity (mm/hour, equivalent water depth), w : flow rate of ground water (cc/min·m²), T : snow temperature (°C, equal to air temperature), T_s : water temperature in sprinkling point (°C), T_e : water temperature in an eave trough (°C).

$$Q_1 = S \times 10^{-1} / 60 \times 5 \times 1 \times 10^4 \times (80 - 0.5T) \quad (1)$$

On the other hand, the heat quantity Q_2 (cal/min) of the flowing water on the roof, 5×1 m² in area, where the terminal temperature will be T_e , is expressed as

$$Q_2 = mc\Delta T = 5w(T_e - 0) \quad (2)$$

where w is the flow rate of water (cc/min·m²), T_e is terminal water temperature. If Q_2 was used completely for snow melting, then the following equation is obtained.

$$Q_1 = Q_2$$

Then, the amount of of snow equivalent to the snowfall intensity of S (mm/hour, equivalent water depth per hour), which will be melted away by ground water, is expressed by

$$S = 6wT_e / [(80 - 0.5T) \times 10^2] \quad (3)$$

By using the equation (3) and Fig. 6 and Fig. 7, the amount of snow melted by ground water can be estimated. For example, in the case of the flow rate of sprinkled water: 0.90 l/min·m², wind velocity: 3.2 m/s, and air temperature: -5°C, and if the sprin-

kled water temperature (T_s) is regarded to be 12.5°C , after 5 m flow the terminal temperature (T_e) becomes 4.5°C in Fig. 7. Substitution of each value into the above equation (3) figures out the value of 2.95 mm/hour snowfall intensity which means that any snowfall less than that of 2.95 mm/hour will be melted away completely.

Accordingly, if the meteorological elements such as snowfall intensity, wind velocity and air temperature are known statistically in a region where the execution of this method of snow melting is being planned, then the appropriate flow rate of ground water between 0.45 to $0.90 \text{ l}/\text{min}\cdot\text{m}^2$ can be calculated by the equation (3) and by the interpolation of Fig. 6 and Fig. 7.

V. Conclusions and Discussions

(1) As to the flow rate of sprinkled ground water of $0.45 \text{ l}/\text{min}\cdot\text{m}^2$ (10°C) at 0°C air temperature, the heat efficiency of snow melting was 68 percent and 38 percent in windless time and in 3 m/s (1 m high on the ground) wind velocity, respectively (Fig. 3). The wind velocity plays a great part in the heat loss of ground water for snow melting.

(2) It was observed that running water did not flow on the whole roof surface evenly when the flow rate and roof pitch were small (Fig. 4). If both the rate and the pitch become larger, the velocity of running water becomes faster. But, when the flow rate becomes larger, the roof will leak. When the roof pitch becomes steeper, only a part of the heat energy of the sprinkled water will be used for snow melting because the time duration for heat exchange from the water to snow becomes short. Consequently, a moderate amount ($0.5\sim 0.6 \text{ l}/\text{min}\cdot\text{m}^2$) of water and a moderate roof pitch ($2/10\sim 3/10$) are necessary to be determined for snow melting on the roof.

(3) As the terminal water temperature of sprinkled ground water on the roof comes close to 0°C , thawing ability of water for snow melting is lost. But in the actual case of snow melting by sprinkled water, even if the thawing ability of snow melting is lost, running water flows in an adequate velocity so far as it does not freeze; so the author considers that the running water washes away the falling snow flakes on the roof surface.

(4) It was observed that there was a difference of terminal water temperature between the field experiment and the cold room experiment: the temperature was higher in the field experiment by about 0.5°C for a flow rate of $0.45 \text{ l}/\text{min}\cdot\text{m}^2$ and by about 1°C for $0.90 \text{ l}/\text{min}\cdot\text{m}^2$, respectively. For the reason of their differences, it is considered that in the actual use on the roof it is very difficult to make the surface smooth, and that water will not flow over the whole surface on the roof but makes a narrow path, and in such a case heat loss of running water is less. On the other hand, in the cold room experiment sprinkled water flew over the whole roof. As to the difference between about 0.5°C for a flow rate of $0.45 \text{ l}/\text{min}\cdot\text{m}^2$ and about 1°C for $0.90 \text{ l}/\text{min}\cdot\text{m}^2$, the reason is not certain but it is presumed that the flowing behavior of sprinkled water in the field experiment and the atmospheric condition in the cold room have an effect on the difference.

(5) For representative meteorological conditions, the amount of snow which can be melted away by sprinkled ground water on the roof was determined by the field and the cold room experiments. The equation between snowfall intensity, and water flow rate, terminal water temperature and snow temperature, was expressed as follows (Fig. 8):

$$S=6wT_e[(80-0.5T)\times 10^2]$$

S : snowfall intensity equivalent to water depth (mm/hour)

w : flow rate of sprinkled water (cc/min·m²)

T_e : terminal water temperature (°C)

T : snow temperature (°C, equal to air temperature)

To obtain the value of the terminal water temperature, Fig. 6 and Fig. 7 will be used.

(6) The results of these snow melting experiments by sprinkling water on the roof have been adopted to practical snow melting on some greenhouses and several roofs in Yamagata Prefecture. The effective discharge of sprinkled water was found to be 0.5~0.6 l/min·m².

For snow melting on roads and parking places, on the other hand, the empirical value of 0.3~0.4 l/min·m² has been adopted and applied to the snowy regions of Tōhoku and Hokuriku.

This snow melting method by sprinkling water is to be applied only in regions where ground water is abundant.

Acknowledgement

The author is indebted to Mr. Yukio Sakano, the former director, and Mr. Hideomi Nakamura for their helpful discussions and technical assistances to this study.

REFERENCES

- 1) Furukawa, I., K. Yanagi, and Y. Nakagawa (1966): Shosetsu no ryusuiryo, hiyō no kenkyu (Study on cost and volume of water for snow melting on the roof). Nihon Sekisetsu Rengō, Data No. 76, pp. 1—22.
- 2) Higashiura, M. (1971, '72): Snow melting on the roof by using ground water. Abstracts for the Annual Meeting of Japanese Snow and Ice Society.
- 3) Higashiura, M. (1972): Research to melt snow on the roof by using ground water. *Water Temperature Research*, vol. 16, No. 4, pp. 10—17.
- 4) Higashiura, M. (1975): On the present situation of snow removal from greenhouses. The Shisetsu Engei Yōran, pp. 131—140.
- 5) Japanese Construction and Machinery Society (1968): Bosetsu kōgaku handobukku (Handbook of technology for snow disaster prevention) J.C.M.S., pp. 209—222.
- 6) Ministry of Agriculture Forestry, Promotion Bureau (1961): Handbook of agricultural meteorology. Yōkendo Co. pp. 1—16.
- 7) Nakamura, H. and M. Higashiura (1970, '71, '72): Snow melting on the road by using ground water. Abstracts for the Annual Meeting of Japanese Snow and Ice Society.
- 8) Saito, H. (1976): On the theory of melting snow by sprinkling subterranean water on roadway. *Report of the Institute of Snow and Ice Studies*, pp. 1—16.
- 9) Yuhara, K. and M. Higashiura (1972): Research of ground water resources for snow melting. *Report of Scientific Research Fund from the Ministry of Education*, pp. 7—10.
- 10) Yuhara, K. and K. Kitaoka (1973): Research of ground water resources for snow melting—Ground water in Nagaoka City—. *ibid.*, pp. 6—15.

(Manuscript received 11 Dec. 1976)

散水による屋根雪消雪

東 浦 将 夫

国立防災科学技術センター新庄支所

近年の著しいモータリゼーションに伴い、雪国の都市では道路雪氷対策と共に、家屋の密集した地区の屋根雪処理が一層深刻な問題となってきた。一方、道路除雪のための消雪用熱源として、地下水が手軽に利用できるため、地下水による消雪道路が著しく普及してきた(湯原・東浦, 1972; 湯原・北岡, 1973)。屋根雪消雪にも地下水を利用した消雪パイプが実用化されてきている(東浦, 1975)。そこで、限りある地下水を有効に使うために、この最適散水量を決定する必要がある。本稿では、異なる気象条件下における屋根に散布した地下水の温度の低下を測定し、その結果から消雪可能量を求めた。野外実験では、2組の小規模実験屋根(A, B)を使用した。これらの屋根への散水量は、道路消雪で用いられている経験値(0.3~0.4 l/min・m²程度)を参考にし、A屋根には、毎分、1 m²あたり 0.45 lの散水量で、B屋根には、毎分、1 m²あたり 0.90 lの散水量で常時散布した。散布した地下水の消雪効率の低下は、風速により著しく影響され、散水量 0.45 l/min・m² (10°C) の水温低下の方が 0.90 l/min・m² より大きかった(図1, 図2)。また、散水量 0.45 l/min・m² (10°C) で、気温 0°C の場合、消雪効率は風速 3 m/s で 38% に、無風時で 68% に低下した(図3)。なお、風速 4~5 m/s のときは、降雪は屋根面から吹き飛ばされることが観察された。次に、B屋根を使用して、散水された水の流下状況と流下速度を調べた(図4)。散水量が少なく屋根勾配が小さいと、散水された水は屋根全面に流れない。散水量をあまり多くすると、屋根からの漏水が生ずるため、散水消雪には適度の水量(0.5~0.6 l/min・m²)と屋根勾配(2/10~3/10)が必要である。

野外実験の観測値と比較検討するため低温室内実験を行った。本実験では、散水量、散水温度、風速、屋根勾配を任意に変えて、全面流下させ、水温低下と流下距離の関係を求めた(図6, 図7)。これらの図から散水量の差異による水温低下量($\Delta T = T_s - T_e$, T_s : 散水温度, T_e : 末端水温)が求められる。

野外実験と室内実験での水温低下の差は、散水量 0.45 l/min・m² では、ほぼ 0.5°C、0.90 l/min・m² では、ほぼ 1.0°C 程室内実験の値の方が低かった。これは、実際の屋根面をなめらかに施工することが難しく、水が均等に流下しないものと考えられる。

以上の実験・観察をもとにして、任意の気象条件下における散布した地下水の消雪可能量を求める式を導いた。

$$S = 6wT_e / [(80 - 0.5T) \times 10^3]$$

但し、 S は単位時間の降水高で示した降雪量(mm/h)、 w は単位面積への単位時間あたりの散水量(l/min・m²)、 T_e は末端水温(°C)、 T は降雪の温度(°C)である。 T_e は散水温度低下図(図6, 図7)から求める。この式を用いて1例を調べてみる。散水量 0.90 l/min・m²、風速 3.2 m/s、気温 -5°C のとき、散水温度低下図(図7)から散水温度(T_s)を 12.5°C とすると、末端水温(T_e)は 4.5°C となり、各々の値を上式に代入すると、降雪強度(S) 2.95 mm/h まで消雪が可能となる。

* 雪害防災研究室