

平塚沖波浪観測資料 (1)

渡部 勲* 藤縄幸雄**

国立防災科学技術センター平塚支所

Wind Wave Observation off Hiratsuka

By

Isao Watabe and Yukio Fujinawa

Hiratsuka Branch,

National Research Center for Disaster Prevention, Japan

Abstract

Wind waves were observed at a marine observation tower off Hiratsuka in the Sagami Bay by the use of a capacitance-type wave-gauge. Data were sampled every one hour through computer-based telemetering system.

Wave statistics were done on the basis of the zero-up-cross method and of the spectral analysis method.

1. 波浪観測の方法

平塚支所においては、昭和42年から波浪等観測塔（詳しくはセンター要覧）に設置された波高計を用いて2時間毎、10分間の波高記録を続けてきたが、これらの観測記録はアナログ記録であるために読み取る必要があった。このたびデータ採取制御装置の更新に供い、デジタルデータとして収集、処理、保存などが可能となった。

ここに一般の用に供するため、その結果を報告するものである。波浪観測塔は、相模湾の平塚沖約1 km、水深20 mの地点（東経139°20′，北緯35°18′）に設置されている（図1参照）。

観測塔の構造は、図2に示すようになっており、波高計は、漂流物による損傷を避けるため、北側に取り付けてある。波高の検出には、容量式の波高計を用いている。センサーは、5 mm φの引込用被覆動力線を使用し、センサーの下部には、鉄材によるオモリが取り付けられてあり、センサーに付着する生物の除去の便も図っている。そのため、流れの強い時には、若干センサーが垂直からずれることがあるが実用上問題となる程度ではない。データの収集は、データ採取制御システム（図3）によって行っている。容量式波高計からの出力は、A/D変換器に入り、デジタル信号化され、海底ケーブルを通して、陸上のデータ受信部に取り込まれる。データは、1時間ごとに正時から10分間、サンプリング間隔0.3秒で採取され、ディスクに書き込まれ、1週間ごとに磁気テープにファイルされる。

* 沿岸防災第2研究室

** “ 第1 “



図1. 波浪等観測塔設置位置



図2. 波浪観測塔の概観. 容量型波高計は(●)印の場所に設置されている.

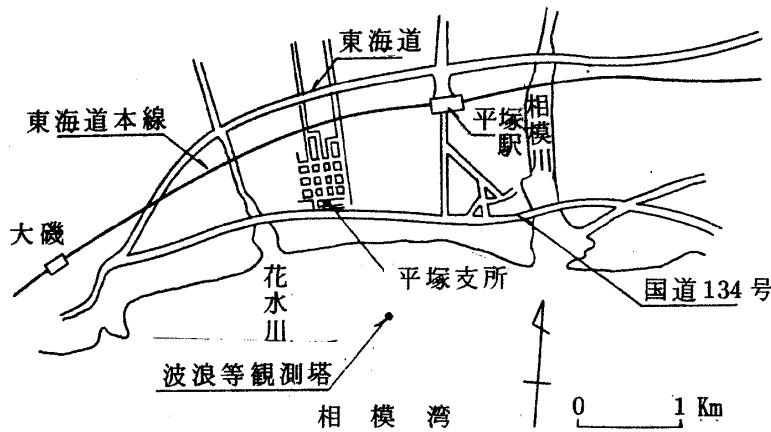
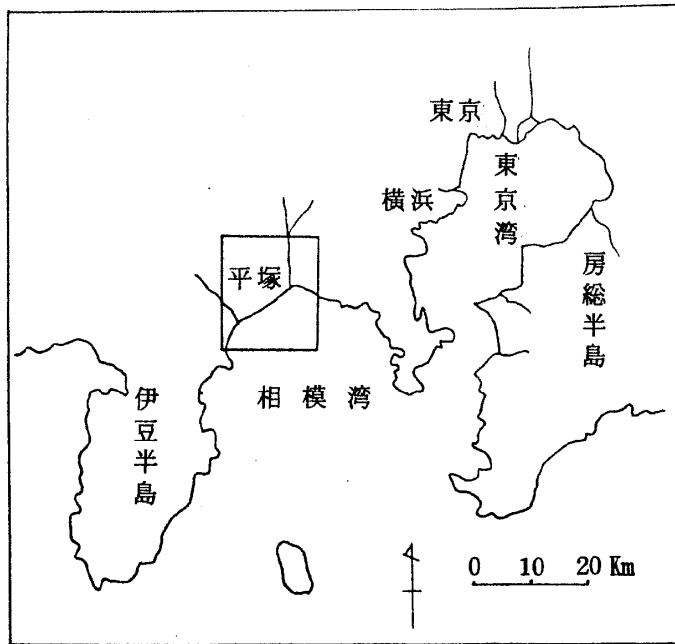

図3. データ採取制御システムブロック図.

2. データの処理

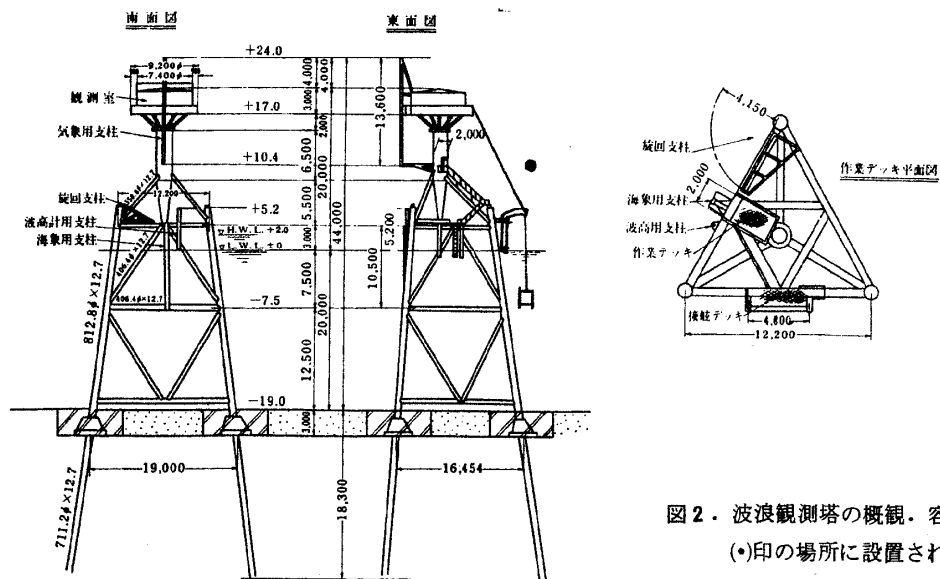
データの処理は、ゼロアップクロス法による波浪統計処理と、スペクトル解析処理の2通りの仕方で行っている。波浪統計処理結果は、次の項目が記載されている。

HOUR	データ取得時刻		
WAVE NUMBER	ゼロアップクロス法による処理波の数		
T (AVE)	平均周期 (単位sec, 以下同じ)		
H (AVE)	平均波高 (単位cm, 以下同じ)		
T (1/3)	1/3 最大波の周期	H (1/10)	1/10 最大波の波高
H (1/3)	1/3 最大波の波高	T (MAX)	最大波の周期
T (1/10)	1/10 最大波の周期	H (MAX)	最大波の波高

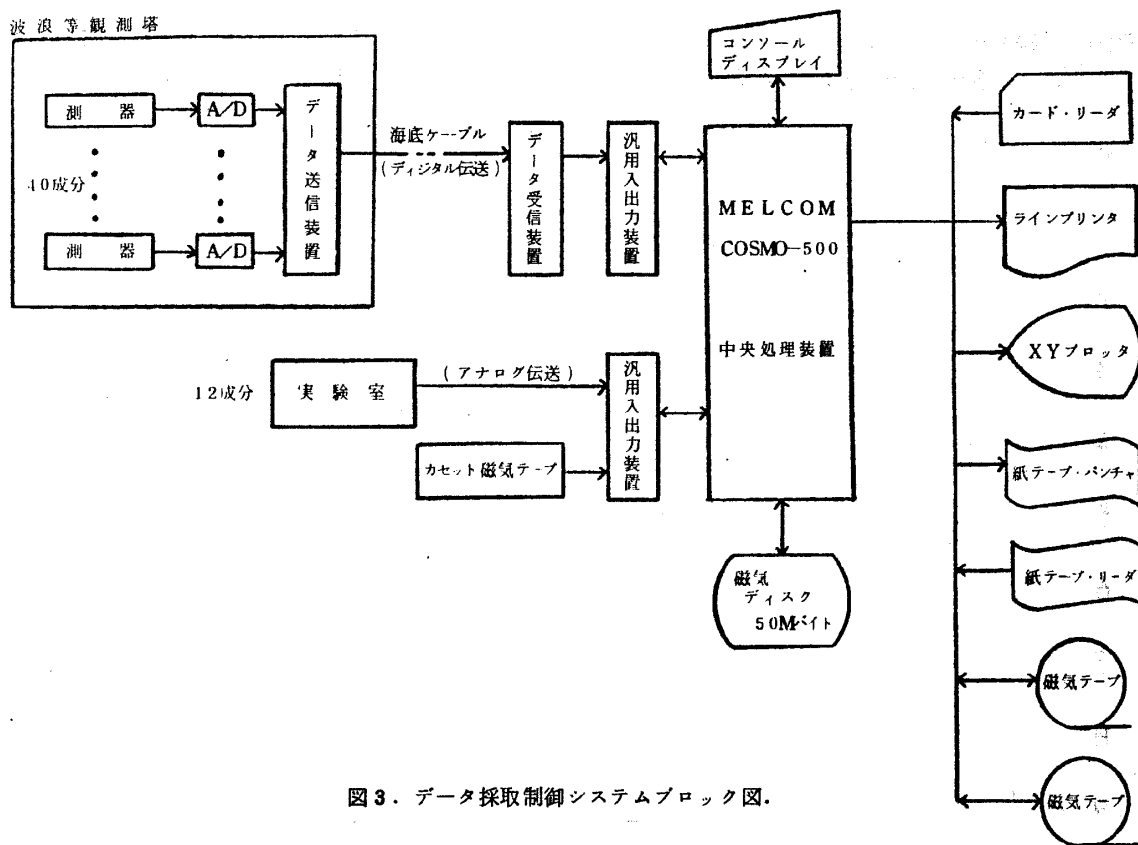
なお、ここで言う1/n最大波とは、サンプル波を波高を規準にして順序づけ、大きい方の1/n個の波の集まりを言う。

波浪のパワースペクトルは、図4のように表わされている。グラフ中の文字(17H)は、データ取得時刻を示し、横軸には、周波数 (Hz) の常用対数がとってある。たとえば、"0"は1 Hz, "1"が10 Hzを表わしている。縦軸はパワースペクトル密度 $E(f)$, ($\text{cm}^2 \cdot \text{s}$) の常用対数表示である。



図4. 波浪のパワースペクトルの例示

1978 11 07

HOUR	WAVE NUMBER	T (AVE)	H (AVE)	T (1/3)	H (1/3)	T (1/10)	H (1/10)	T (MAX)	H (MAX)
0									
1									
2									
3									
4									
5									
6									
7									
8									
9									
10									
11									
12									
13									
14									
15									
16	86	6.8	38.8	9.5	65.5	10.2	79.6	11.4	96.3
17	99	6.0	31.6	9.7	57.6	10.8	77.8	11.7	91.9
18	81	7.2	37.9	10.2	61.3	10.1	73.3	9.6	99.2
19	77	7.7	38.5	10.2	63.0	10.2	73.4	9.6	84.2
20	94	6.3	29.8	8.7	49.8	8.8	62.1	9.6	74.3
21	74	7.9	41.3	11.1	66.6	10.2	75.3	11.1	96.3
22	82	7.3	36.9	10.7	61.0	10.7	73.6	9.3	89.4
23	81	7.4	35.9	9.7	57.8	10.1	78.7	9.3	99.6

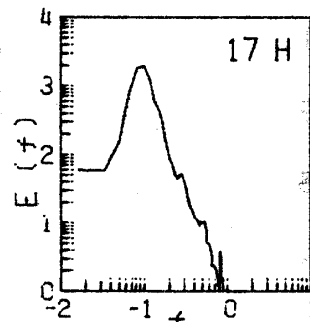
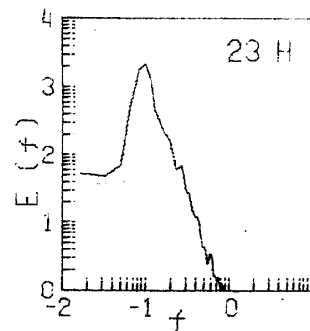
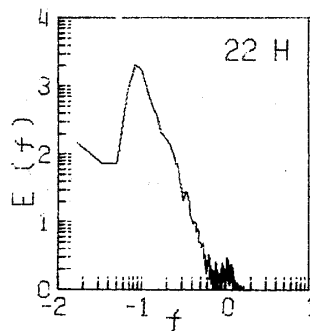
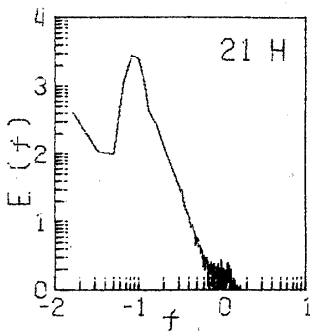
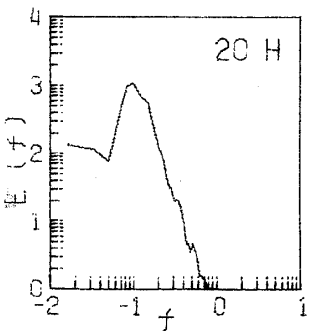
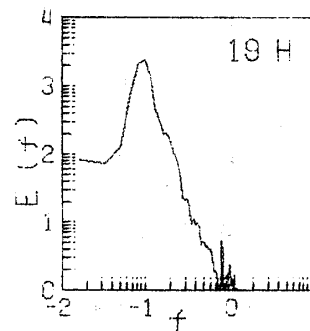
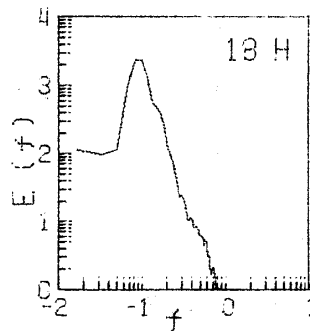
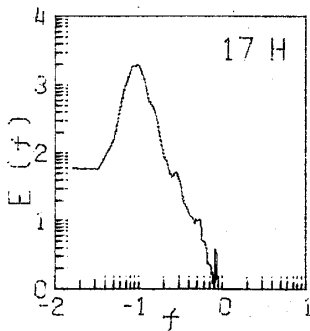
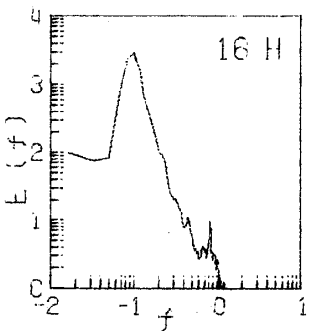
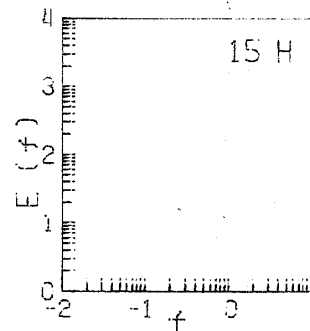
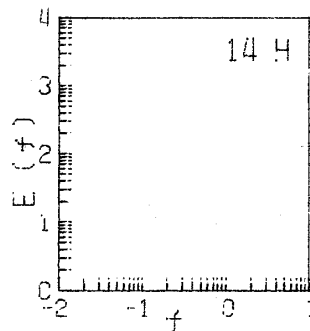
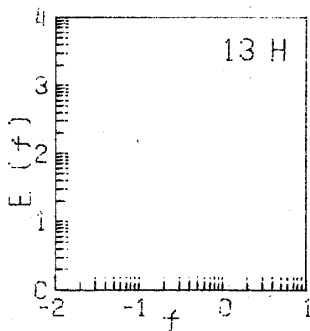
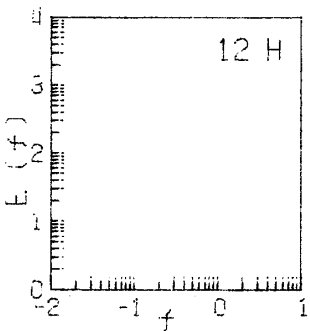
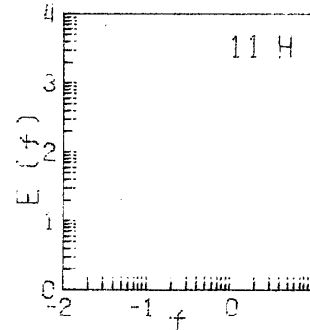
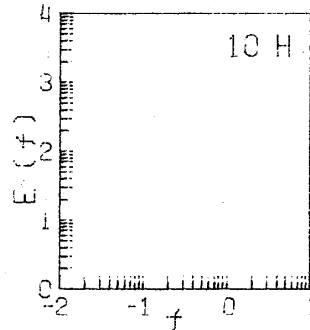
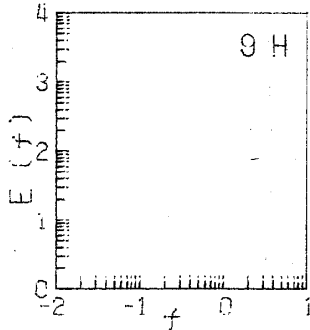
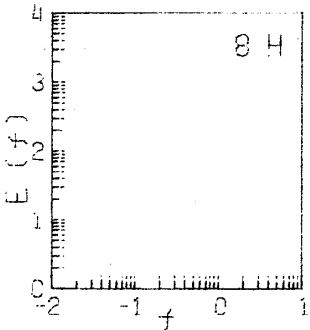
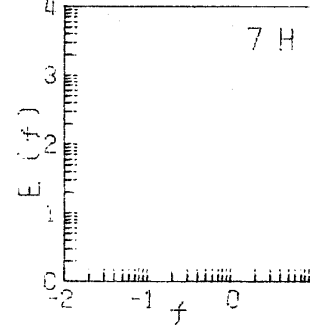
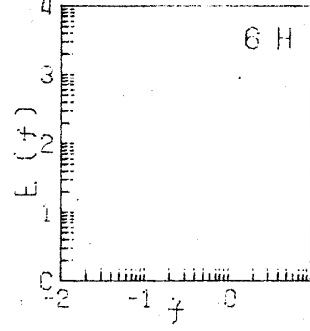
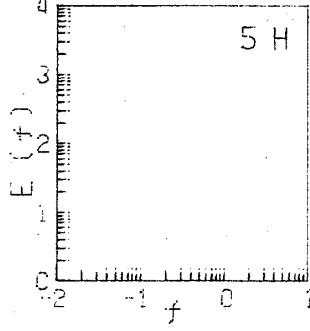
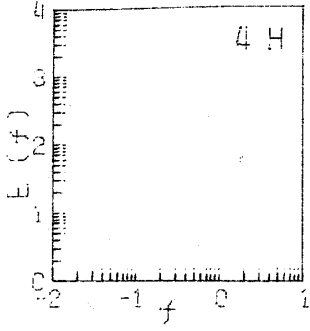
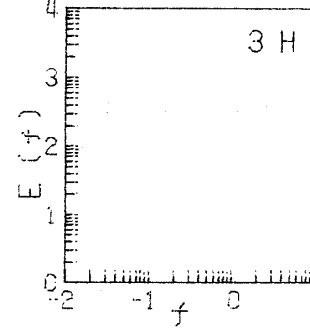
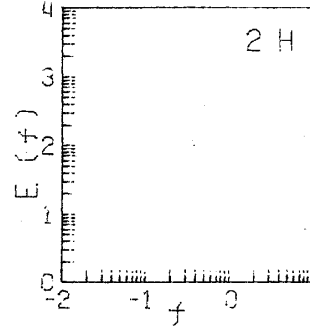
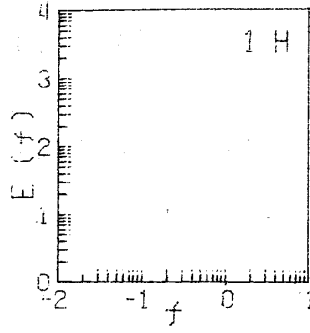
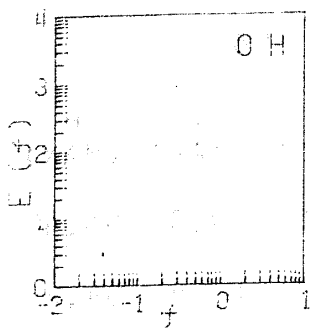

1978 11 08

HOUR	WAVE NUMBER	T (AVE)	H (AVE)	T (1/3)	H (1/3)	T (1/10)	H (1/10)	T (MAX)	H (MAX)
0	105	5.7	20.0	8.6	35.9	10.2	47.1	9.3	56.4
1	75	8.0	27.3	10.0	42.0	9.6	49.5	10.8	54.6
2	95	6.3	14.9	10.0	25.2	10.5	31.3	11.4	41.0
3	70	8.4	12.6	10.0	20.7	10.1	24.1	9.9	26.0
4	64	9.4	12.1	10.0	22.1	9.6	30.6	10.5	43.2
5	73	8.1	11.4	10.3	20.8	10.4	30.4	9.9	43.2
6	101	5.8	12.0	8.7	19.4	8.8	22.0	10.2	23.8
7	102	5.7	17.2	9.4	30.5	9.6	39.7	8.4	43.9
8	125	4.7	17.3	7.9	31.4	9.5	43.7	10.2	58.6
9	117	5.1	24.5	8.7	41.4	9.0	51.4	8.1	64.1
10	148	4.0	21.5	7.5	37.9	8.9	51.8	9.3	68.5
11	124	4.8	22.8	8.6	40.8	9.7	53.9	9.9	66.7
12	144	4.1	20.0	7.2	37.0	9.1	56.6	9.9	76.5
13	151	4.0	18.6	7.1	34.6	9.1	50.7	11.7	63.4
14	141	4.2	18.3	7.2	32.3	9.0	42.2	6.9	48.7
15	133	4.5	18.8	7.6	31.8	8.7	41.5	8.1	50.5
16	168	3.5	20.2	5.2	30.9	7.5	39.6	7.5	45.8
17	152	3.9	16.7	5.9	27.1	7.0	34.8	7.5	47.6
18	134	4.4	13.9	7.1	23.5	9.5	32.2	10.2	43.2
19	123	4.8	18.0	7.5	28.6	9.0	37.6	9.9	46.9
20	119	4.9	20.7	8.2	34.4	9.2	42.5	9.9	46.9
21	122	4.8	20.0	8.6	35.9	10.2	46.0	9.6	52.4
22	141	4.2	17.6	7.1	30.5	8.3	38.2	9.9	55.3
23	124	4.8	20.0	8.0	35.2	10.2	46.4	8.4	75.4

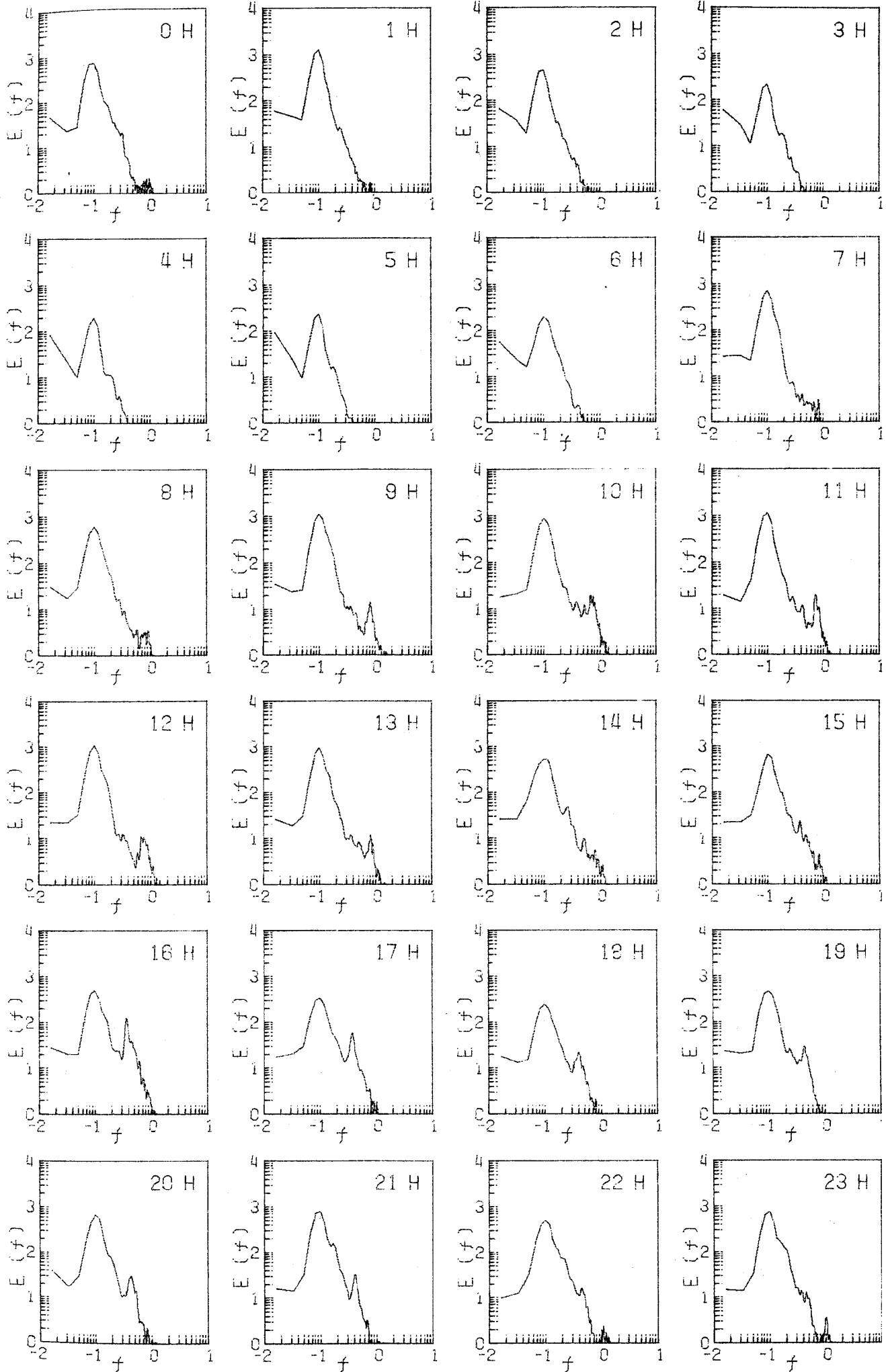

1978 11 09

HOUR	WAVE NUMBER	T (AVE)	H (AVE)	T (1/3)	H (1/3)	T (1/10)	H (1/10)	T (MAX)	H (MAX)
0	154	3.9	16.8	6.5	29.0	8.2	38.5	6.6	48.7
1	135	4.4	15.9	6.9	25.8	8.4	33.2	10.5	42.1
2	137	4.4	9.8	7.0	18.1	7.7	25.6	7.5	42.8
3	135	4.4	9.6	7.4	16.9	8.6	22.9	11.1	32.6
4	151	3.9	9.1	6.8	15.4	7.8	20.3	9.3	33.0
5	161	3.7	7.2	6.3	12.5	6.7	15.2	5.7	19.0
6	143	4.2	7.8	7.1	14.4	7.7	17.5	6.9	19.8
7	144	4.1	8.8	6.9	14.3	7.8	17.5	7.5	20.9
8	130	4.6	8.2	7.1	15.6	8.3	20.7	6.6	26.7
9	117	5.1	14.3	7.7	22.7	9.3	28.2	11.7	31.1
10	111	5.3	20.5	8.2	34.0	8.6	42.6	7.8	46.5
11	128	4.6	19.2	6.7	32.0	7.3	40.4	7.2	54.6
12	120	5.0	22.8	6.6	35.8	7.0	44.1	8.1	52.7
13	125	4.8	20.4	7.6	35.8	8.1	45.9	10.2	61.2
14	122	4.9	19.9	7.2	33.0	8.1	45.6	9.9	59.7
15	119	5.0	22.5	6.9	35.9	7.8	43.5	6.3	52.4
16	112	5.3	23.5	7.6	36.6	7.5	42.9	6.0	45.4
17	138	4.3	21.0	7.0	35.9	7.5	44.3	9.9	57.1
18	159	3.7	20.7	5.9	36.5	7.1	45.8	6.3	53.8
19	182	3.3	16.0	5.2	28.2	6.8	38.4	7.8	49.1
20	166	3.6	16.9	6.0	28.8	7.9	39.5	6.6	57.9
21	198	3.0	15.6	5.0	25.3	7.1	34.0	6.9	45.4
22	193	3.1	19.1	5.1	30.4	6.9	39.9	8.4	46.1
23	155	3.8	20.9	6.5	36.2	7.9	46.5	7.5	54.9

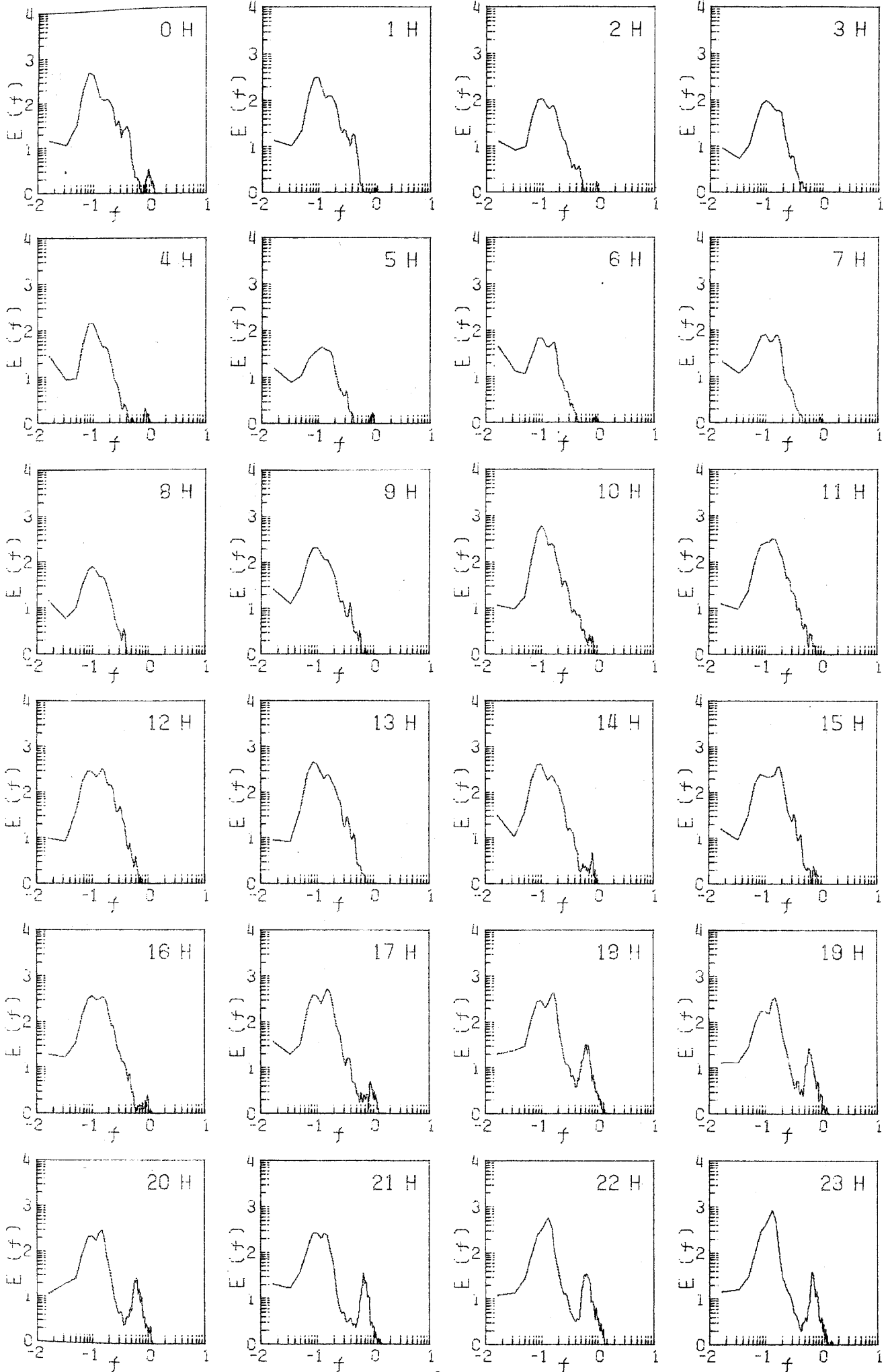

1978 11 10

HOUR	WAVE NUMBER	T (AVE)	H (AVE)	T (1/3)	H (1/3)	T (1/10)	H (1/10)	T (MAX)	H (MAX)
0	171	3.5	19.5	5.8	31.9	7.8	42.4	8.7	56.0
1	163	3.6	17.5	6.3	30.3	8.2	40.2	11.1	50.5
2	184	3.2	17.7	5.6	29.1	7.6	40.5	9.3	77.3
3	190	3.1	14.4	5.0	22.7	6.6	28.8	9.0	43.9
4	165	3.6	11.1	5.7	19.0	7.0	25.6	8.1	33.0
5	190	3.1	9.8	5.2	14.8	7.0	19.1	5.7	26.4
6	165	3.6	8.1	5.8	11.9	7.7	13.7	10.2	15.0
7	167	3.6	5.8	6.0	9.2	7.3	10.8	10.2	12.8
8	189	3.2	7.1	5.1	10.5	7.0	12.6	9.0	14.6
9	146	4.0	8.4	6.4	13.9	6.4	17.0	7.2	19.0
10	143	4.1	14.9	6.1	23.1	6.1	28.1	6.6	34.4
11	138	4.3	20.4	6.5	32.1	7.2	39.6	5.1	47.2
12	140	4.2	20.6	6.4	33.7	7.0	42.0	6.3	50.9
13	134	4.4	21.6	6.5	36.1	6.6	45.8	9.0	56.4
14	125	4.7	18.9	7.3	31.8	7.9	39.9	7.8	54.6
15	111	5.3	25.0	7.4	38.9	8.1	47.6	6.9	57.1
16	114	5.2	25.5	6.9	38.6	7.3	47.1	9.0	54.9
17	120	4.9	21.9	6.6	34.9	7.2	45.2	8.7	64.8
18	127	4.7	17.8	7.4	30.7	9.0	40.0	7.2	50.9
19	138	4.3	17.0	7.3	30.2	8.7	38.1	7.8	51.6
20	121	4.9	21.4	8.2	37.6	9.0	47.1	7.8	55.3
21	129	4.6	17.9	8.3	32.8	9.5	40.8	9.9	50.2
22	149	4.0	15.9	6.6	29.4	7.2	40.4	6.9	52.0
23	146	4.0	16.9	6.5	29.9	7.6	40.2	6.9	51.3

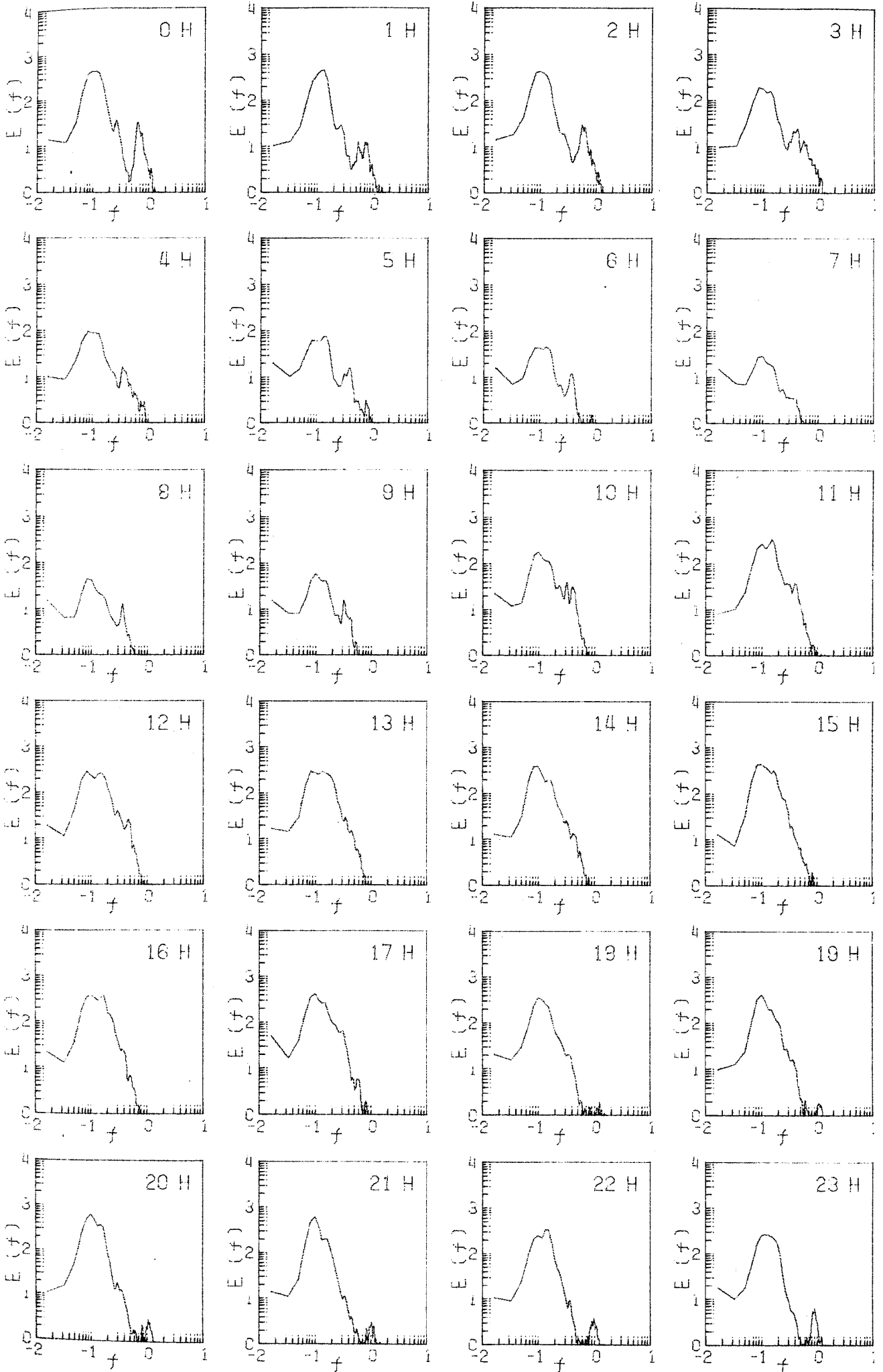

1978 11 11

HOUR	WAVE NUMBER	T (AVE)	H (AVE)	T (1/3)	H (1/3)	T (1/10)	H (1/10)	T (MAX)	H (MAX)
0	165	3.6	16.4	6.4	29.0	8.1	39.6	5.7	48.0
1	170	3.5	14.9	5.6	24.5	7.3	31.3	8.1	46.1
2	181	3.2	13.4	6.0	22.9	8.1	31.0	9.0	41.0
3	159	3.8	13.9	6.9	24.4	9.1	34.8	8.7	43.9
4	139	4.2	13.9	7.9	25.2	9.4	32.8	9.6	42.8
5	149	4.0	13.7	7.3	25.1	9.2	34.7	7.8	39.6
6	148	4.0	13.9	7.4	25.5	9.4	35.3	8.7	49.1
7	140	4.3	13.8	7.5	24.6	9.3	32.5	9.6	38.1
8	143	4.2	15.1	6.9	25.8	8.7	34.3	8.1	45.4
9	200	3.0	11.0	5.2	18.2	6.8	24.4	5.7	29.3
10	166	3.6	12.3	6.4	22.0	8.5	30.3	9.0	42.5
11	133	4.5	14.3	7.6	26.0	8.7	35.7	9.9	43.2
12	153	3.8	16.9	6.5	29.9	7.3	37.5	8.7	43.2
13	147	4.0	18.7	6.6	32.2	7.8	41.6	8.7	48.0
14	153	3.9	19.9	6.5	34.6	7.7	44.3	8.7	52.0
15	156	3.8	19.2	6.6	35.9	7.9	47.4	7.2	56.8
16	138	4.3	21.1	6.6	35.4	7.6	46.7	8.1	59.3
17	143	4.1	18.4	6.5	31.5	7.2	39.7	10.2	45.0
18	120	5.0	20.1	7.7	34.2	7.8	44.2	11.4	58.2
19	102	5.8	21.0	7.3	31.2	7.9	36.2	9.9	41.7
20	117	5.1	17.0	7.8	30.5	8.7	39.9	7.8	48.0
21	118	5.1	20.3	7.2	35.7	7.1	45.2	6.6	53.1
22	114	5.2	24.8	7.4	42.9	7.2	54.3	6.9	67.4
23	121	4.9	21.6	7.2	36.5	7.0	46.7	7.2	78.0

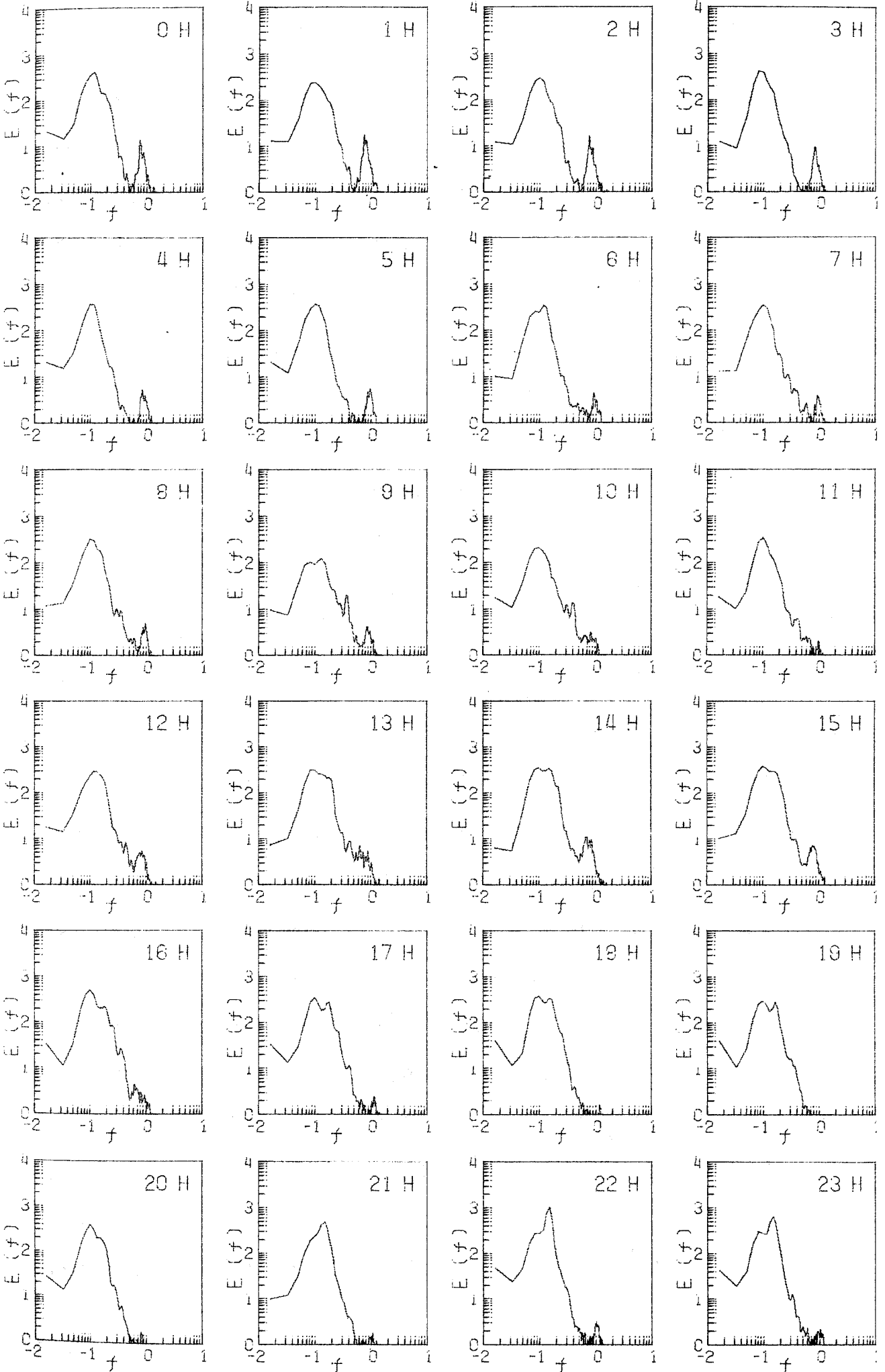

1978 11 12

HOOR	WAVE NUMBER	T (AVE)	H (AVE)	T (1/3)	H (1/3)	T (1/10)	H (1/10)	T (MAX)	H (MAX)
0	118	5.0	25.1	6.9	44.1	6.4	55.1	6.3	80.6
1	124	4.7	24.5	7.3	43.9	7.4	59.5	6.0	87.2
2	138	4.3	21.9	6.7	37.6	7.1	48.6	7.8	57.9
3	110	5.4	21.4	7.8	36.7	7.6	45.5	5.7	54.6
4	106	5.5	23.5	8.1	41.3	8.8	53.7	9.0	69.6
5	127	4.6	21.6	6.8	37.1	7.1	46.3	8.7	57.9
6	132	4.5	20.0	7.0	35.7	7.6	46.9	7.2	59.0
7	117	5.1	20.4	8.4	36.5	7.9	47.4	8.7	57.5
8	140	4.3	17.7	7.4	31.8	7.9	40.6	7.8	53.8
9	151	3.9	16.3	7.0	29.5	8.0	36.9	10.5	43.9
10	166	3.6	12.4	6.1	22.2	8.5	31.0	6.0	39.9
11	163	3.7	12.1	6.1	20.9	7.3	26.7	7.2	33.3
12	176	3.4	11.5	5.4	19.4	6.7	24.6	8.7	30.0
13	180	3.3	11.7	5.2	19.3	5.8	25.4	5.4	30.8
14	179	3.3	12.9	5.6	21.2	7.2	28.2	9.0	37.4
15	177	3.4	12.9	5.7	21.9	6.9	28.5	8.1	34.8
16	190	3.1	15.9	5.1	26.7	6.5	33.5	7.2	39.6
17	139	4.3	18.4	6.4	29.0	7.4	37.9	7.2	44.3
18	150	3.9	13.3	6.5	22.3	7.4	28.8	7.8	39.6
19	134	4.4	17.3	7.3	29.9	7.8	37.7	7.2	52.4
20	144	4.1	15.9	6.7	27.3	8.4	37.4	7.8	53.1
21	154	3.9	15.8	6.4	26.5	7.6	35.1	8.1	43.6
22	158	3.8	15.4	6.4	26.8	7.7	34.1	7.5	46.5
23	149	4.0	14.5	6.5	27.2	7.3	35.7	6.0	42.8

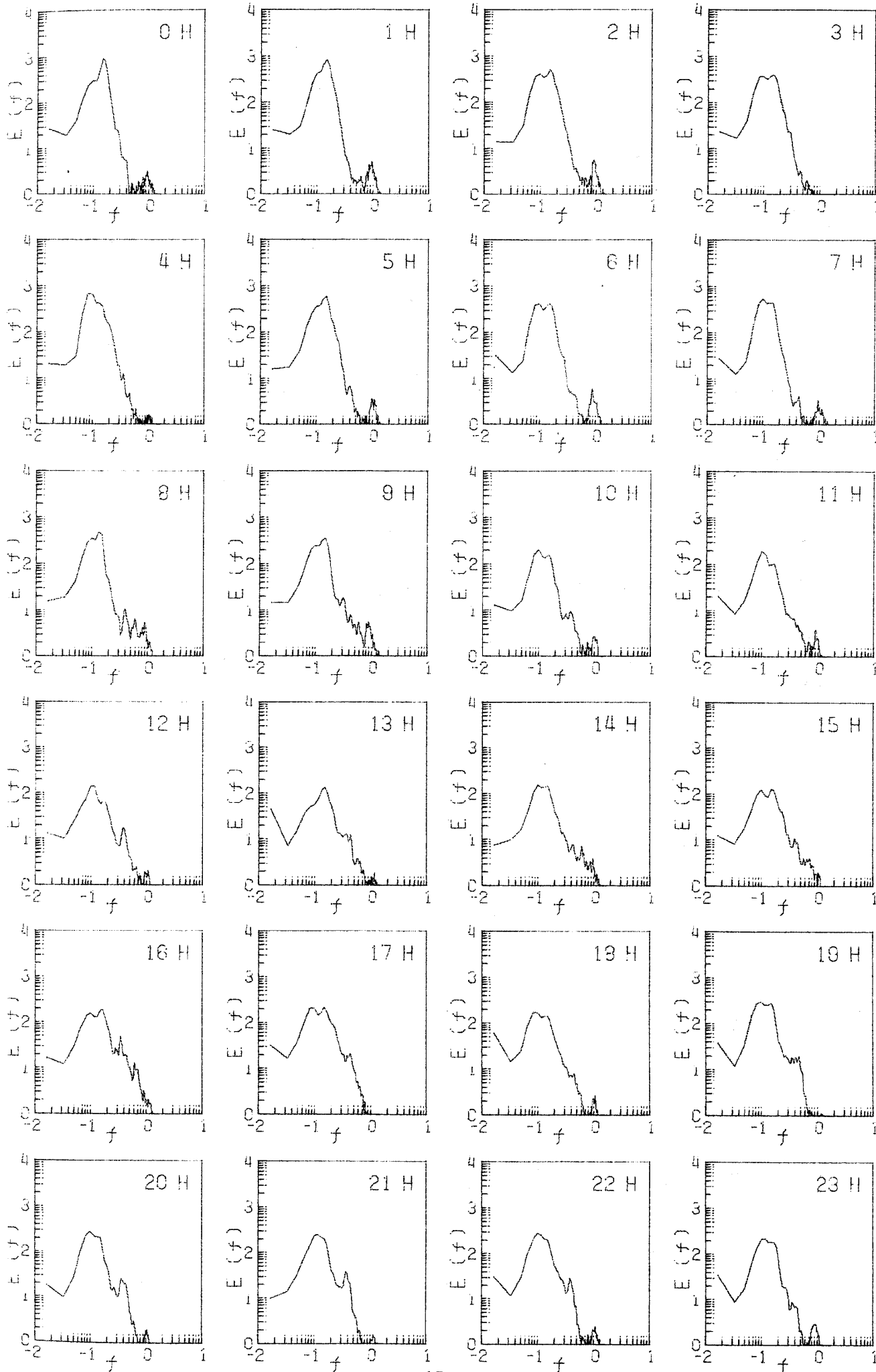

1978 11 13

HOUR	WAVE NUMBER	T (AVE)	H (AVE)	T (1/3)	H (1/3)	T (1/10)	H (1/10)	T (MAX)	H (MAX)
0	158	3.8	13.5	6.4	24.5	7.3	32.3	8.1	42.1
1	158	3.7	15.3	6.1	26.2	7.8	35.7	6.9	46.5
2	166	3.6	14.0	5.9	23.6	6.8	30.7	7.2	41.4
3	182	3.3	14.0	5.5	24.0	7.0	34.2	6.6	47.6
4	193	3.1	15.6	5.0	26.5	6.8	36.9	7.5	49.1
5	210	2.8	15.1	4.5	24.8	6.5	34.9	9.9	47.6
6	186	3.2	17.0	5.3	27.4	7.5	36.3	7.8	50.2
7	212	2.8	17.8	4.4	28.1	5.3	34.2	6.3	47.6
8	167	3.6	16.4	6.2	28.7	7.8	40.4	6.3	56.0
9	169	3.5	18.3	5.7	30.3	7.0	39.8	5.1	49.4
10									
11									
12									
13									
14									
15									
16									
17									
18	173	3.4	19.3	6.2	34.1	8.7	49.0	8.4	58.6
19	165	3.6	24.6	6.2	41.1	8.5	55.2	9.0	67.0
20	154	3.8	21.9	6.4	39.0	8.5	53.0	8.7	72.1
21	143	4.2	23.3	7.5	42.2	8.5	57.0	8.7	72.1
22	158	3.7	25.3	6.6	43.7	8.5	62.6	9.3	73.2
23	123	4.8	34.3	8.0	60.8	8.6	77.2	9.3	98.1

1978 11 14

HOUR	WAVE NUMBER	T (AVE)	H (AVE)	T (1/3)	H (1/3)	T (1/10)	H (1/10)	T (MAX)	H (MAX)
0	140	4.3	28.6	7.7	52.4	8.3	68.9	8.7	106.9
1	129	4.5	35.8	8.1	66.6	8.2	87.6	8.4	125.2
2	95	6.2	51.8	8.5	89.6	8.5	117.7	8.4	144.7
3	101	5.9	39.3	8.3	66.0	8.4	84.4	8.4	105.5
4	109	5.5	41.4	8.3	72.9	8.3	95.0	8.4	113.5
5	110	5.4	41.2	8.6	74.3	8.1	88.2	8.4	98.9
6	113	5.3	37.7	8.4	70.8	8.2	91.6	7.5	113.9
7	127	4.7	34.3	7.8	63.1	8.5	86.9	9.0	116.1
8	117	5.1	39.8	8.4	76.0	8.9	99.4	9.0	114.3
9	136	4.4	30.5	7.9	57.2	8.3	77.6	9.0	105.1
10	119	4.9	33.2	7.9	58.7	8.0	71.0	8.4	94.1
11	132	4.5	34.9	7.8	65.9	8.2	85.0	8.7	113.5
12	129	4.6	29.4	7.8	54.9	7.9	73.5	7.5	88.6
13	130	4.5	30.5	7.5	51.7	7.8	61.7	8.4	88.3
14	125	4.8	37.9	7.6	69.2	7.6	97.0	7.2	117.2
15	138	4.3	28.8	7.0	50.6	7.4	66.0	7.2	93.0
16	146	4.0	28.7	6.7	49.4	7.5	67.1	7.8	101.1
17									
18									
19									
20									
21									
22									
23									

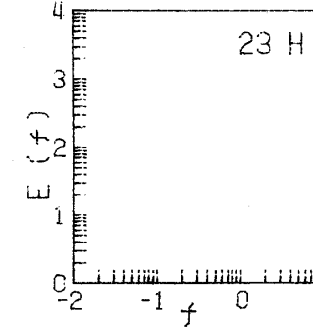
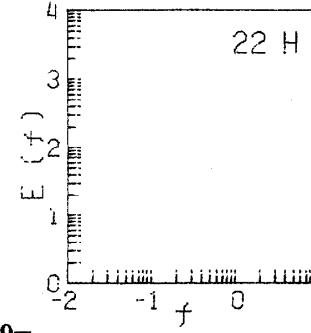
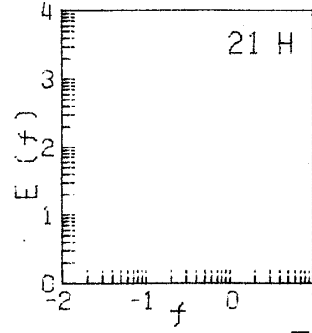
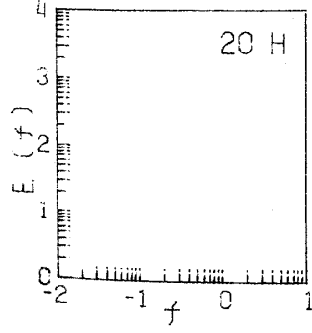
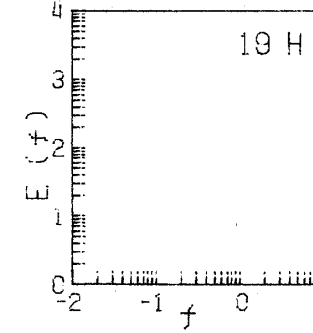
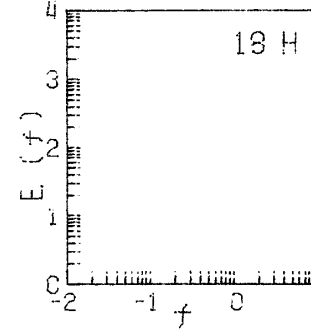
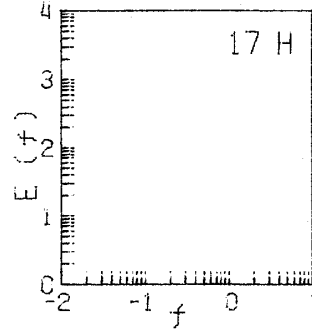
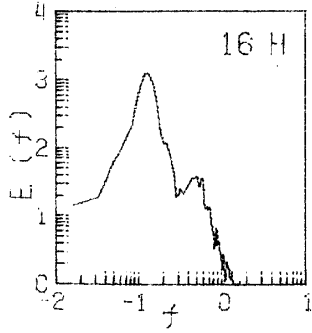
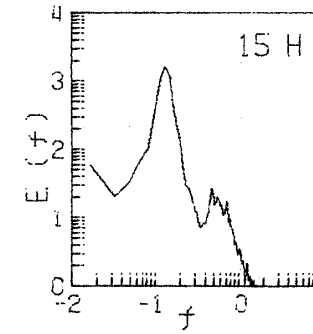
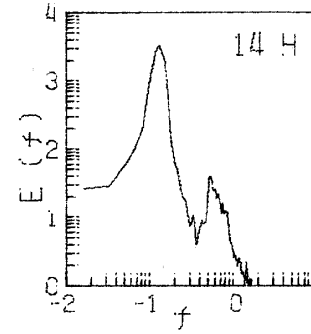
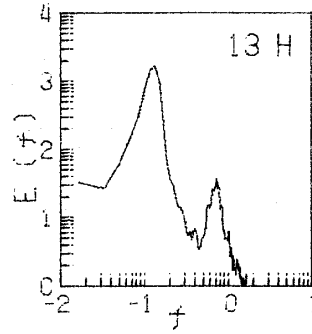
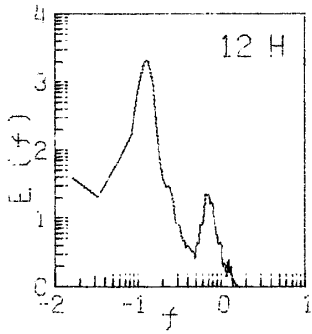
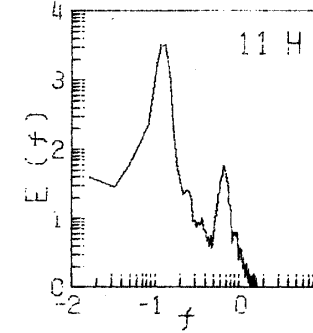
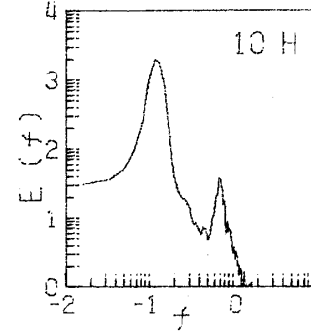
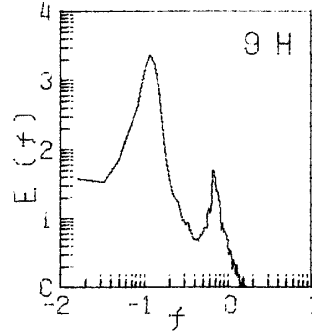
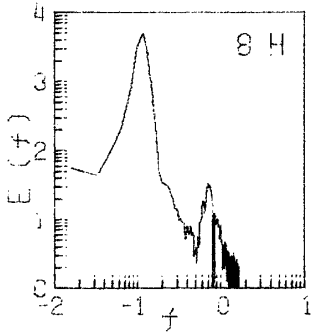
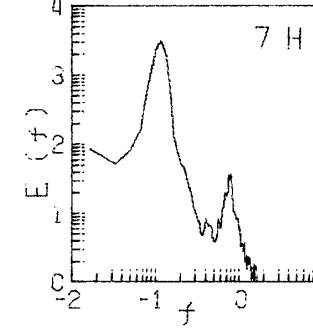
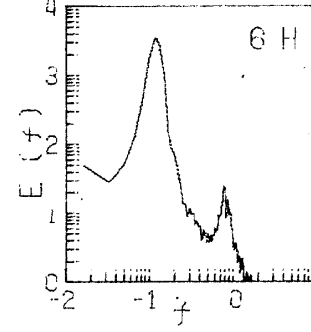
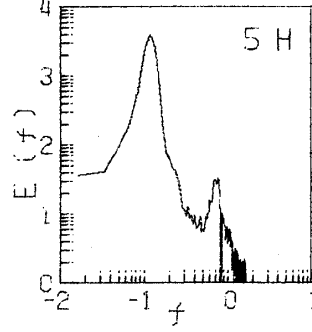
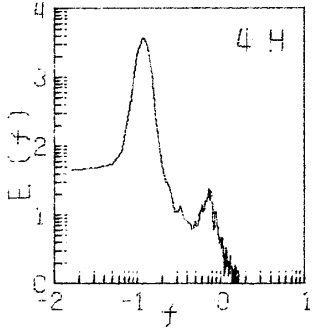
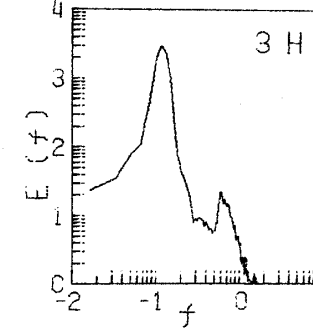
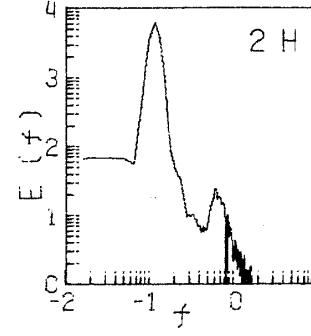
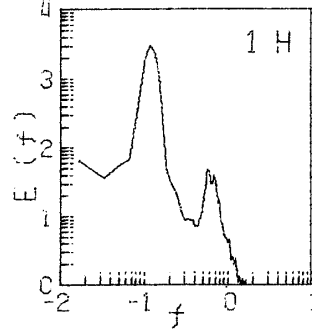
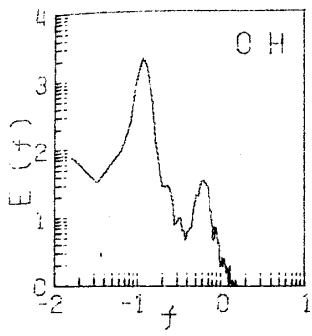

1978 11 15

HOUR	WAVE NUMBER	T (AVE)	H (AVE)	T (1/3)	H (1/3)	T (1/10)	H (1/10)	T (MAX)	H (MAX)
0									
1									
2									
3									
4									
5									
6									
7									
8									
9									
10	160	3.7	45.3	5.2	68.2	6.2	84.8	10.5	104.7
11	165	3.6	67.4	3.9	100.4	3.7	123.6	3.9	160.0
12	170	3.5	72.3	4.1	110.1	4.2	134.5	3.6	176.1
13	160	3.7	76.2	4.4	115.8	4.6	135.8	4.8	155.3
14	164	3.6	83.1	4.5	133.6	4.5	170.4	4.2	258.2
15	148	4.0	98.1	4.7	151.8	5.1	188.9	4.8	230.7
16	151	4.0	94.8	4.7	146.8	4.7	190.2	4.8	242.4
17	149	4.0	84.8	4.9	132.0	4.8	163.1	4.8	193.0
18	145	4.1	70.4	5.1	113.0	5.2	140.7	5.4	170.3
19	127	4.7	66.2	5.3	99.7	4.9	127.4	5.7	177.2
20	125	4.8	51.6	5.7	80.0	5.3	98.8	4.5	116.1
21	114	5.2	47.0	6.3	76.0	5.9	95.2	7.5	121.6
22	121	4.9	40.9	6.2	64.1	5.4	78.1	4.8	102.9
23	115	5.2	42.1	6.4	67.1	6.6	81.7	5.4	109.5

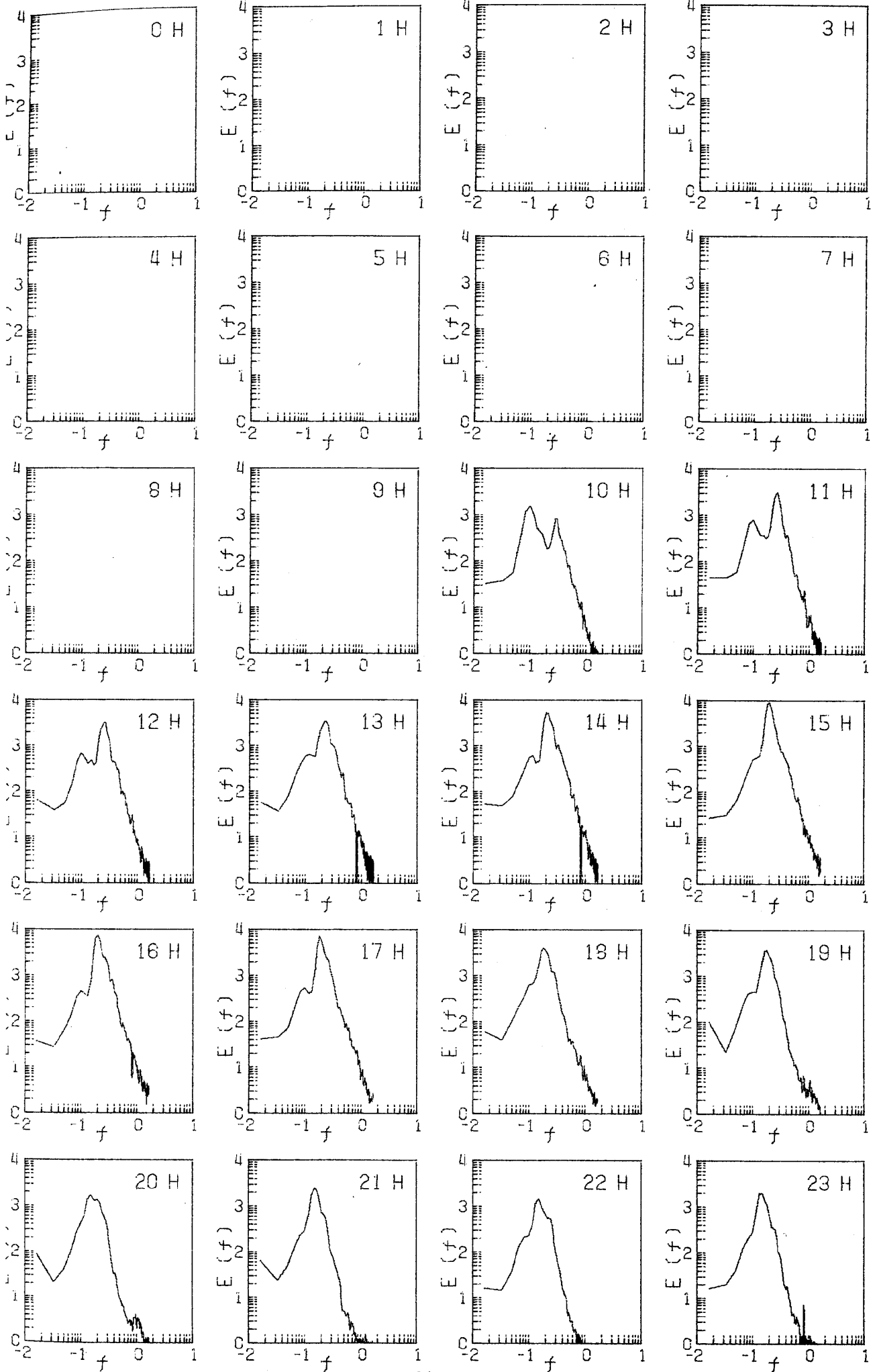

1978 11 16

HOUR	WAVE NUMBER	T (AVE)	H (AVE)	T (1/3)	H (1/3)	T (1/10)	H (1/10)	T (MAX)	H (MAX)
0	122	4.9	38.2	6.3	61.2	6.4	81.4	6.3	105.5
1	107	5.5	43.4	6.2	74.1	6.1	97.0	6.3	123.4
2	117	5.1	35.7	6.9	57.8	6.8	75.1	7.2	96.7
3	122	4.9	32.6	6.7	53.7	6.6	67.2	5.4	90.8
4	129	4.6	26.4	7.1	46.9	7.9	58.3	6.9	69.2
5	149	4.0	20.1	6.6	36.7	7.3	50.6	6.0	68.1
6	130	4.6	23.9	7.4	41.7	7.9	52.7	7.2	61.5
7	166	3.6	19.8	6.5	35.5	7.3	48.0	7.8	55.7
8	181	3.3	19.2	5.6	31.3	7.0	41.0	6.3	50.5
9	156	3.8	22.5	6.7	39.6	7.2	51.0	6.9	66.3
10	116	5.1	28.3	7.3	47.9	7.6	62.1	7.5	72.5
11	112	5.3	24.8	6.9	40.5	7.2	49.1	6.6	58.2
12	114	5.2	25.4	6.8	41.3	6.8	50.4	6.6	63.4
13	134	4.4	24.1	6.4	40.4	6.4	50.7	6.9	68.5
14	148	4.0	27.8	6.2	44.0	6.7	54.3	6.0	67.7
15	162	3.7	27.5	5.7	43.7	7.1	53.6	6.9	69.9
16	155	3.9	26.9	5.5	43.6	7.3	55.1	11.1	63.7
17	163	3.7	24.4	5.3	37.5	6.4	46.5	8.1	64.8
18	179	3.3	22.3	4.9	35.5	5.6	47.3	6.3	56.4
19	174	3.4	21.3	5.6	34.6	6.6	43.9	7.2	56.4
20	169	3.5	14.9	5.4	24.3	6.9	32.3	7.8	45.0
21	157	3.8	18.4	6.4	30.5	7.3	40.6	8.7	53.1
22	157	3.8	16.5	6.0	26.3	6.8	32.5	6.6	45.8
23	152	3.9	18.5	6.0	29.6	7.7	37.2	9.0	48.0

1978 11 17

HOUR	WAVE NUMBER	T (AVE)	H (AVE)	T (1/3)	H (1/3)	T (1/10)	H (1/10)	T (MAX)	H (MAX)
0	154	3.8	15.8	7.0	27.6	7.9	34.8	7.8	42.5
1	172	3.5	14.3	6.0	24.8	7.2	32.0	6.6	42.1
2	167	3.5	15.9	5.9	27.1	7.6	38.1	9.0	49.1
3	181	3.3	17.2	5.7	28.7	7.6	39.2	7.5	59.7
4	182	3.2	16.0	5.8	27.5	6.9	38.7	9.0	59.7
5	192	3.1	15.2	5.5	25.3	7.3	33.4	7.5	46.5
6	198	3.0	14.3	4.8	23.0	6.8	30.2	10.5	48.0
7	191	3.1	13.6	5.9	23.9	8.5	33.2	8.4	49.8
8	194	3.1	12.9	5.3	21.8	7.5	29.5	8.4	38.8
9	205	2.9	12.8	4.8	20.8	6.8	28.1	8.7	38.5
10	180	3.3	11.9	5.5	19.7	7.4	27.2	7.2	41.4
11	148	4.0	11.8	6.8	21.2	8.4	28.9	8.4	33.0
12	199	3.0	11.1	5.3	18.8	7.3	26.9	7.8	36.3
13	188	3.2	12.6	5.4	21.2	6.8	28.1	5.7	37.0
14	168	3.5	14.9	5.9	24.9	6.8	32.8	7.5	38.1
15	167	3.5	15.3	6.2	27.3	7.1	36.1	7.5	49.4
16	199	3.0	15.4	4.9	25.7	6.8	34.2	6.9	42.5
17	212	2.8	13.4	5.0	22.6	5.8	31.7	6.6	49.8
18	162	3.7	15.6	6.2	27.4	6.6	36.9	6.3	53.5
19	189	3.2	13.0	5.5	22.4	7.5	33.3	7.5	52.7
20	179	3.3	11.1	6.1	20.2	7.1	27.1	5.7	41.7
21	137	4.3	10.6	6.6	18.0	7.7	23.4	9.0	28.6
22	186	3.2	9.9	5.6	17.0	7.4	22.9	6.6	30.4
23	151	3.9	8.7	6.4	15.3	7.7	20.7	8.4	33.0

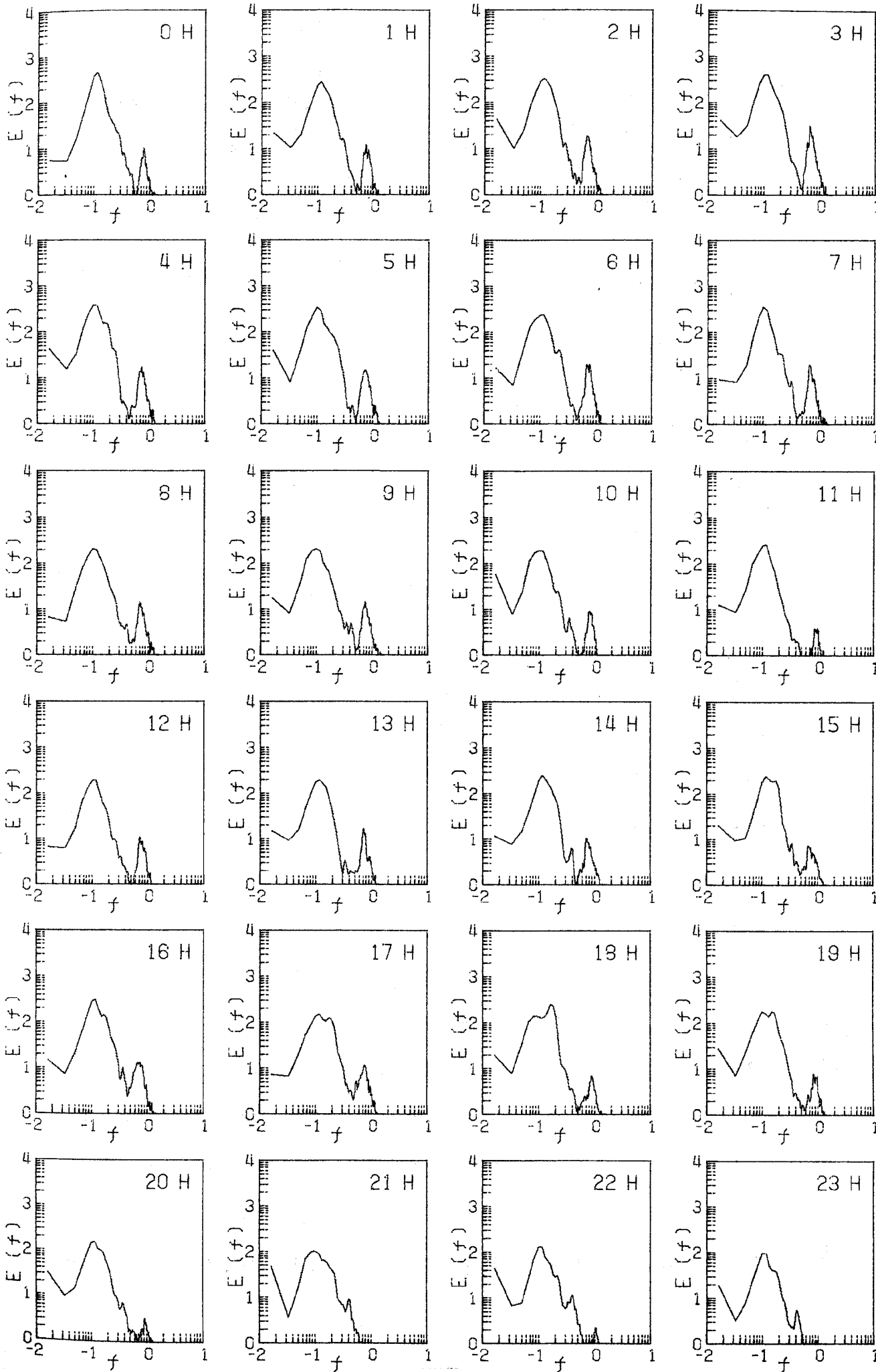

1978 11 18

HOUR	WAVE NUMBER	T (AVE)	H (AVE)	T (1/3)	H (1/3)	T (1/10)	H (1/10)	T (MAX)	H (MAX)
0	168	3.5	9.9	5.6	17.1	6.4	23.4	7.2	32.6
1	150	3.9	12.5	6.2	22.5	6.4	28.7	6.3	35.2
2	137	4.4	13.8	6.4	24.2	7.6	31.2	6.3	41.4
3	148	4.0	15.1	6.1	26.3	6.8	34.6	8.7	46.9
4	136	4.3	15.8	6.1	26.0	7.0	34.3	8.4	46.5
5	147	4.0	15.4	6.2	25.8	7.8	34.0	8.7	41.7
6	141	4.2	15.5	7.1	28.6	7.7	38.1	6.3	45.4
7	139	4.3	15.4	6.3	26.2	6.7	33.3	6.9	53.5
8	148	4.0	15.2	6.5	25.2	7.1	30.9	7.2	42.8
9	158	3.8	14.2	6.7	26.1	7.3	34.7	7.5	45.0
10	142	4.2	14.9	6.9	25.9	7.7	33.2	7.8	45.0
11	134	4.4	16.4	7.0	27.0	8.0	33.1	7.2	38.1
12	132	4.5	15.7	7.3	26.3	8.0	33.4	9.6	39.2
13	127	4.7	13.9	7.1	21.7	7.4	25.5	7.8	29.3
14	103	5.8	15.8	7.9	25.3	7.8	30.8	7.8	43.2
15	133	4.5	18.9	6.9	32.4	7.2	41.5	6.3	52.0
16	144	4.1	18.0	6.4	32.8	7.2	45.2	7.8	58.6
17	127	4.7	16.9	6.9	27.5	7.9	34.2	4.8	38.5
18	148	4.0	16.6	6.5	28.8	8.0	36.4	5.4	46.1
19	177	3.4	16.0	5.6	27.1	6.7	36.2	7.2	42.8
20	157	3.8	15.3	5.8	25.1	7.5	33.0	7.5	42.5
21	135	4.4	13.2	6.7	21.7	7.3	27.5	7.5	37.0
22	126	4.7	14.0	7.7	23.3	9.0	29.6	12.0	34.1
23	131	4.5	12.9	7.4	22.8	8.8	29.7	7.5	42.5

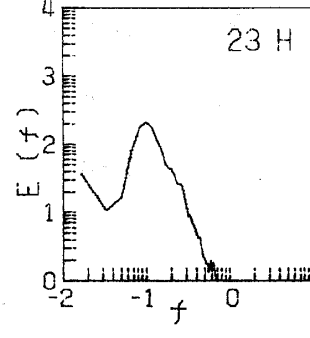
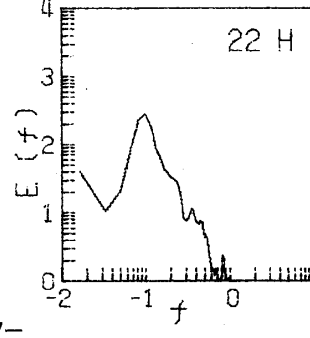
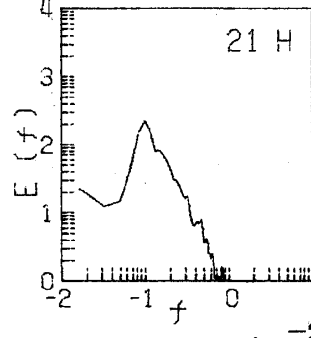
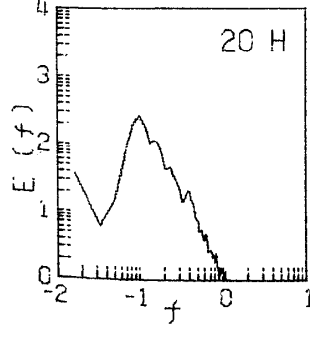
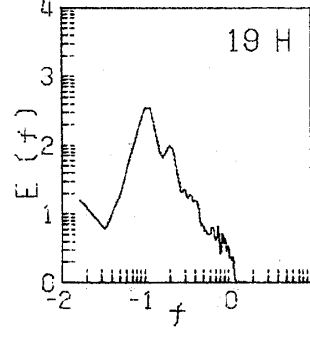
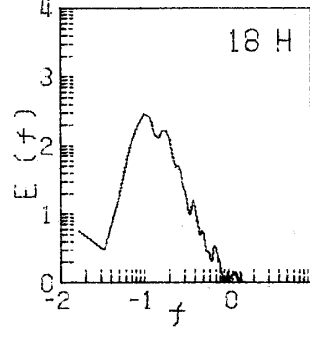
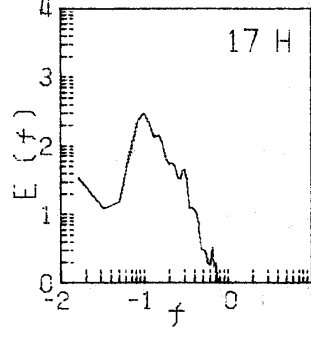
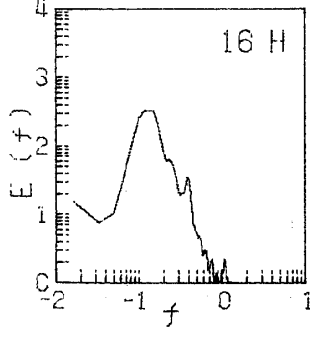
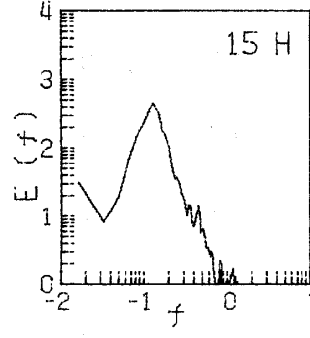
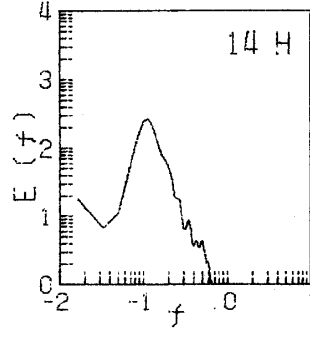
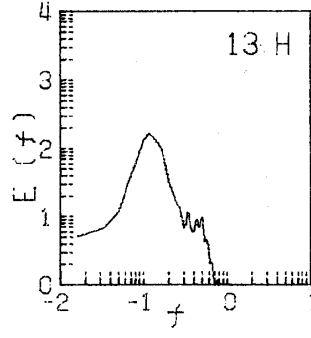
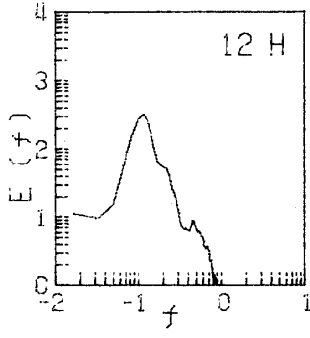
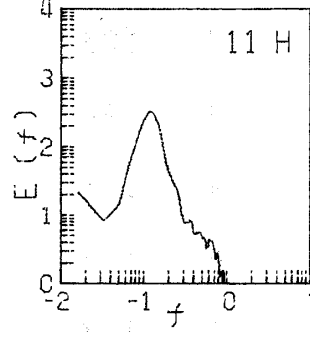
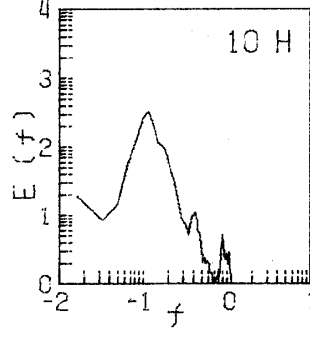
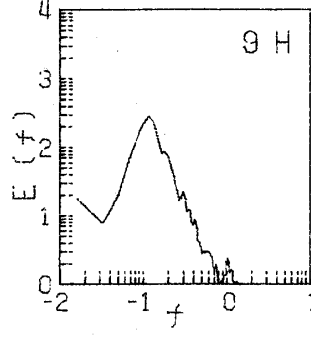
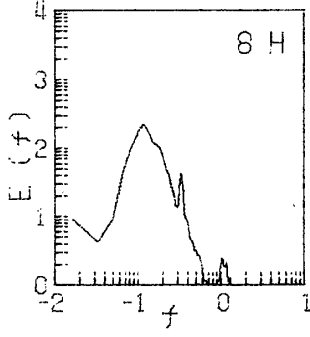
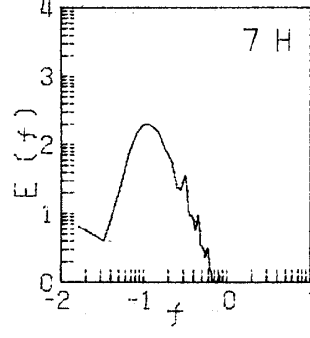
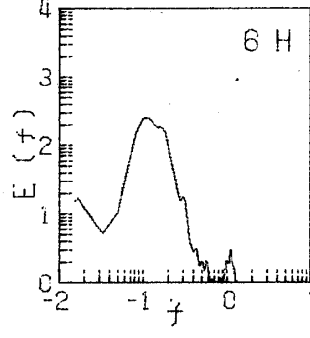
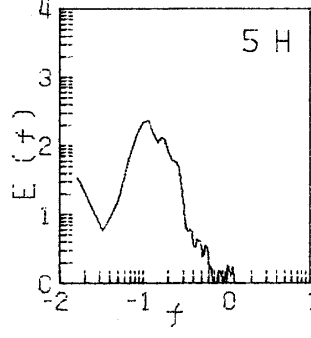
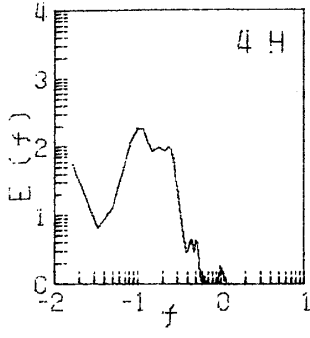
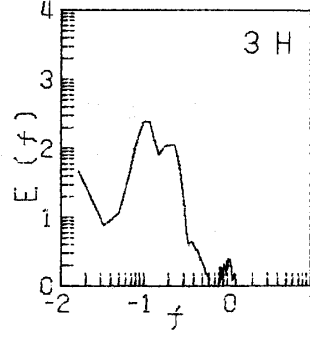
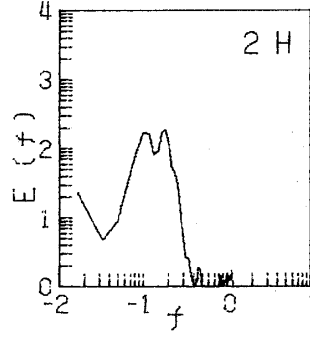
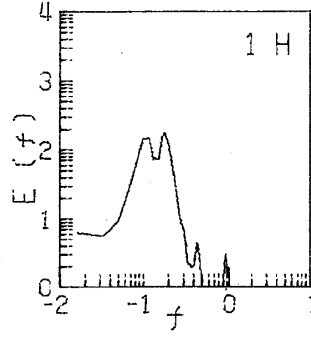
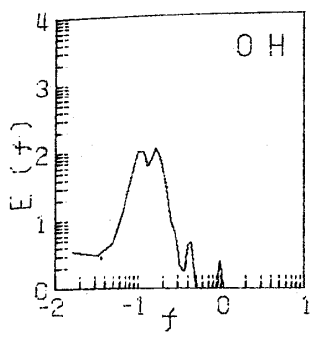

1978 11 19

HOUR	WAVE NUMBER	T (AVE)	H (AVE)	T (1/3)	H (1/3)	T (1/10)	H (1/10)	T (MAX)	H (MAX)
0	121	4.9	8.4	7.1	14.2	8.1	20.0	8.1	28.2
1	111	5.3	11.8	8.1	20.1	9.1	26.6	9.9	33.7
2	121	4.9	17.7	7.1	29.6	7.9	37.7	8.1	50.5
3	135	4.4	24.0	5.9	39.3	6.2	48.6	7.5	59.7
4	128	4.6	33.9	6.3	54.3	6.4	67.4	6.0	78.0
5	148	4.0	29.7	5.5	49.2	5.7	60.2	4.5	79.1
6	148	4.0	28.7	5.7	47.5	5.9	61.6	5.4	83.5
7	123	4.8	37.0	5.8	58.8	5.6	72.7	6.6	98.1
8	128	4.6	50.4	5.7	81.4	5.6	100.9	5.1	115.4
9	123	4.8	58.3	5.8	86.3	5.5	103.7	5.1	144.3
10	117	5.1	44.8	6.6	70.9	6.5	88.0	6.6	104.7
11	113	5.2	51.2	6.6	80.9	6.4	97.0	6.3	115.7
12	100	5.9	57.5	7.3	87.2	7.2	106.0	7.5	128.5
13	99	6.0	70.4	6.9	112.8	7.0	143.4	6.9	158.2
14	111	5.4	84.5	7.3	133.9	7.1	163.8	5.1	177.2
15	117	5.1	89.6	6.5	143.4	6.1	171.6	5.4	184.6
16	138	4.3	85.5	5.8	139.1	6.3	176.6	6.9	231.4
17	131	4.5	79.7	6.0	128.1	6.5	162.3	6.9	187.1
18	123	4.8	93.8	5.8	143.1	5.8	181.0	5.1	235.1
19	125	4.7	89.2	5.6	141.1	6.0	172.4	6.0	203.6
20	125	4.7	73.0	5.5	114.3	5.7	144.9	4.8	193.0
21	126	4.7	65.5	5.9	102.7	5.7	120.3	7.2	140.3
22	126	4.7	53.5	5.7	86.7	5.7	110.6	7.8	132.6
23	130	4.6	49.1	5.9	81.5	6.1	101.9	5.4	135.9

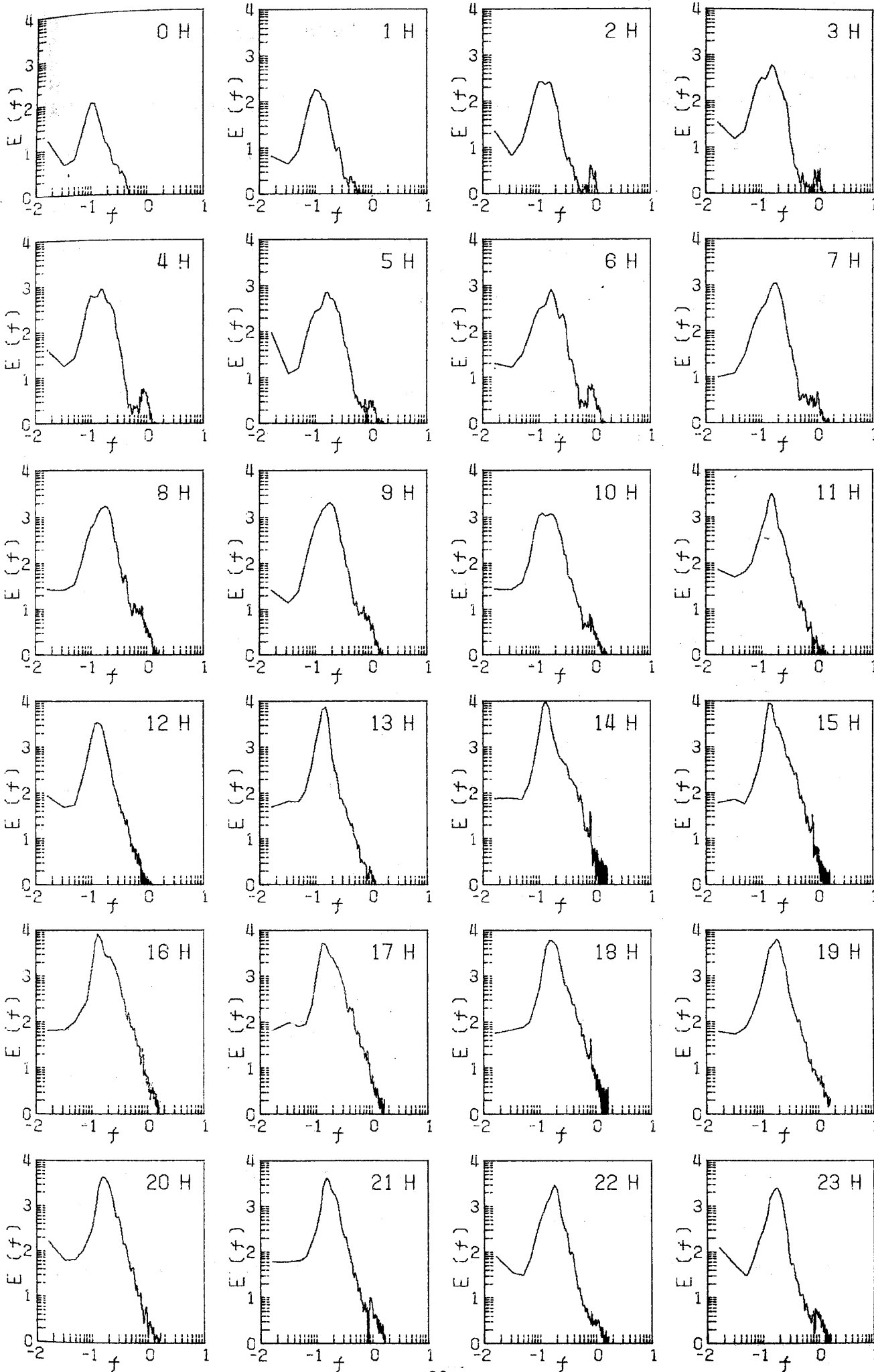

1978 11 20

HOUR	WAVE NUMBER	T (AVE)	H (AVE)	T (1/3)	H (1/3)	T (1/10)	H (1/10)	T (MAX)	H (MAX)
0	116	5.1	50.2	6.1	79.0	6.1	100.1	5.7	116.1
1	120	4.9	31.5	6.1	50.5	6.4	62.3	5.1	80.2
2	118	5.0	32.9	6.3	53.5	6.1	65.3	5.7	72.5
3	112	5.3	35.3	6.2	54.4	6.0	66.7	6.3	76.9
4	115	5.2	37.4	6.2	57.3	5.9	71.2	5.4	90.8
5	116	5.1	40.5	6.7	68.7	6.4	84.4	6.9	107.7
6	113	5.3	46.7	6.5	75.1	6.2	93.6	7.5	106.9
7	123	4.8	37.3	6.4	59.6	6.1	76.4	5.4	112.4
8	129	4.6	32.9	6.5	55.9	6.5	75.4	6.0	89.0
9	116	5.1	37.4	6.8	59.9	7.2	71.1	6.6	87.9
10	96	6.1	59.0	6.9	87.7	6.5	105.5	6.9	119.0
11	103	5.7	54.8	6.4	86.1	6.4	104.4	6.3	126.7
12	118	5.0	35.7	6.7	57.8	6.8	66.4	7.8	73.2
13	111	5.3	35.6	6.4	55.6	6.6	68.9	6.3	94.8
14	124	4.8	29.1	6.3	47.2	6.0	58.8	6.0	73.2
15	146	4.1	26.4	6.1	45.0	6.1	57.3	6.0	71.8
16	189	3.1	23.6	5.1	37.4	5.9	47.0	6.3	59.3
17	161	3.7	25.2	5.8	42.7	6.6	55.3	6.3	67.4
18	169	3.5	22.5	5.8	39.8	6.5	52.5	6.3	72.5
19	170	3.5	20.9	5.9	37.8	6.4	51.3	6.6	66.3
20	178	3.3	17.0	5.7	29.3	6.6	40.7	6.3	54.2
21	160	3.7	17.1	6.2	30.0	6.6	39.8	7.2	48.7
22	168	3.5	14.9	6.0	27.9	6.7	37.7	6.9	48.3
23	142	4.2	16.7	6.4	28.0	6.7	36.2	6.9	41.7

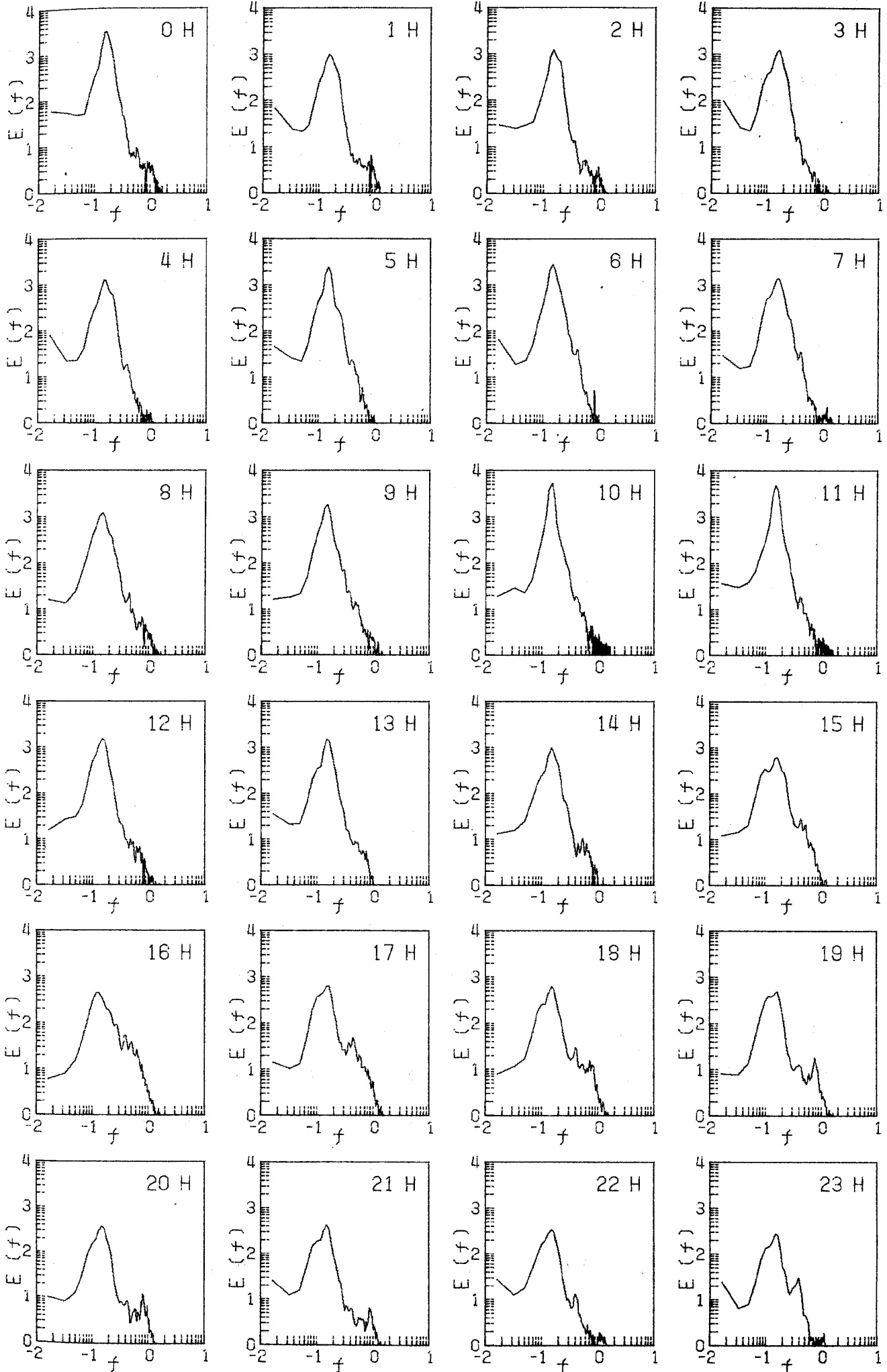

1978 11 21

HOUR	WAVE NUMBER	T (AVE)	H (AVE)	T (1/3)	H (1/3)	T (1/10)	H (1/10)	T (MAX)	H (MAX)
0	145	4.1	16.6	6.2	27.5	7.1	33.0	7.5	37.4
1	132	4.5	13.3	6.6	21.6	7.0	26.8	6.3	33.0
2	137	4.3	11.7	6.5	19.9	6.6	24.9	7.5	38.8
3	134	4.4	13.2	6.8	21.2	6.9	26.2	6.3	34.4
4	162	3.7	12.4	6.2	21.3	7.1	26.8	7.5	31.9
5	162	3.7	13.8	6.0	23.4	7.2	29.8	8.4	37.7
6	160	3.7	15.0	6.1	25.3	6.6	32.6	5.7	37.4
7	160	3.7	14.3	6.6	26.0	7.5	35.8	9.0	43.2
8	172	3.5	13.7	5.9	25.0	7.1	34.8	6.6	51.6
9	162	3.7	14.3	6.7	26.6	7.3	34.9	6.9	43.9
10	171	3.5	14.1	6.0	24.3	7.1	31.7	7.5	42.8
11	176	3.3	13.6	6.2	23.8	7.1	32.2	5.4	41.0
12	127	4.7	16.6	7.4	29.5	7.5	37.8	8.1	56.4
13	122	4.8	17.6	7.3	30.2	7.7	36.5	6.9	40.6
14	173	3.4	16.8	5.8	29.0	6.8	39.6	6.0	53.1
15	151	3.9	24.4	6.3	41.1	7.2	51.9	7.2	70.3
16	140	4.2	22.7	6.8	38.1	7.1	46.2	7.5	63.4
17	139	4.3	22.4	6.2	36.9	7.4	47.2	7.2	56.8
18	144	4.1	24.1	6.5	39.9	6.7	50.2	8.4	65.2
19	145	4.1	20.4	6.3	34.5	7.2	42.9	6.6	49.1
20	139	4.3	19.5	6.7	33.1	8.7	44.6	6.6	55.7
21	175	3.4	17.8	5.6	30.5	7.4	40.7	7.5	67.4
22	160	3.7	18.9	6.4	31.7	7.3	37.8	5.4	44.7
23	175	3.4	17.7	6.0	30.8	7.4	42.6	9.0	53.1

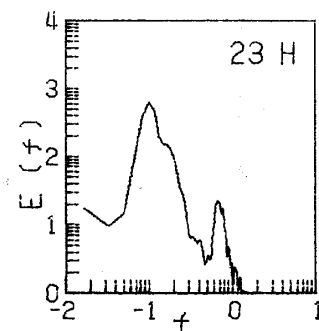
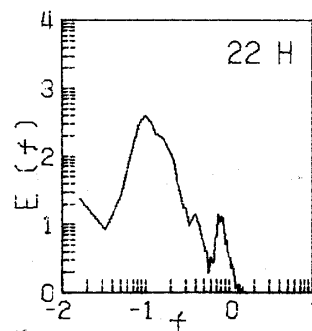
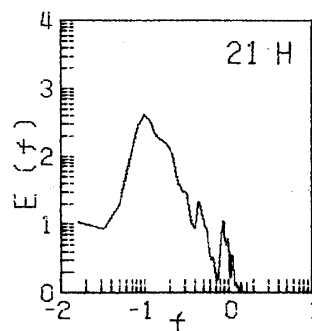
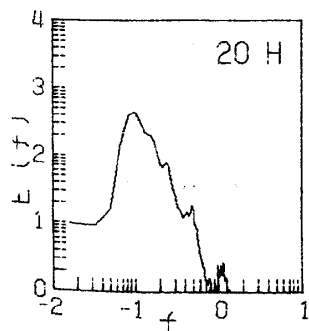
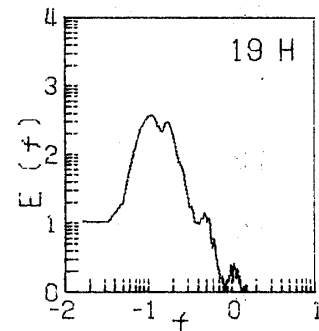
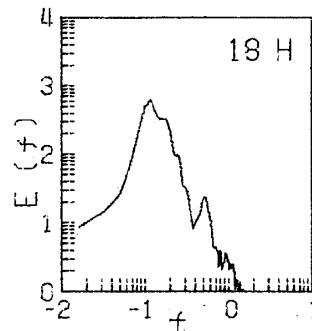
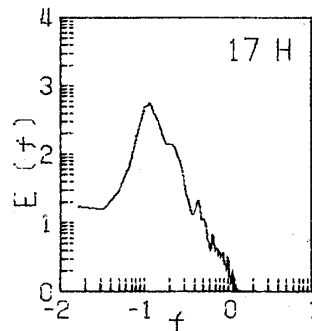
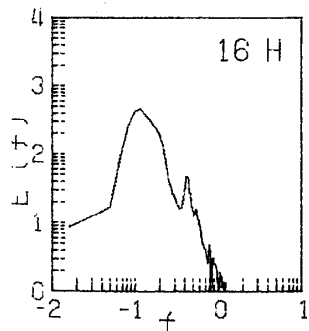
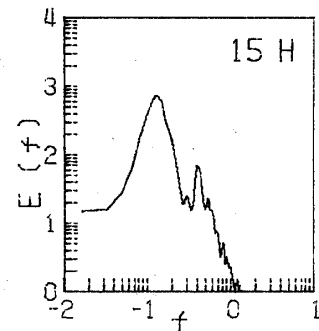
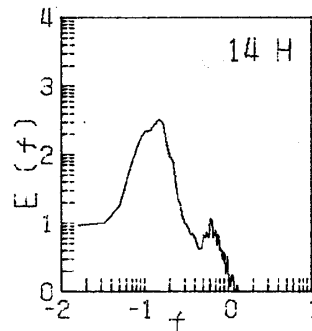
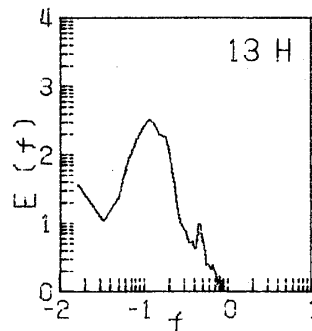
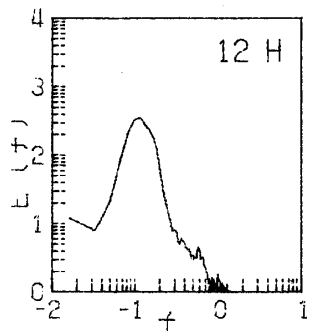
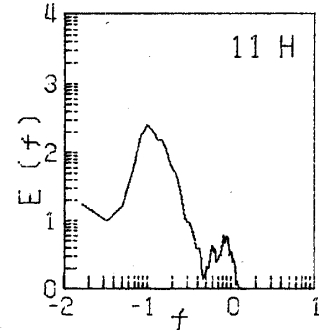
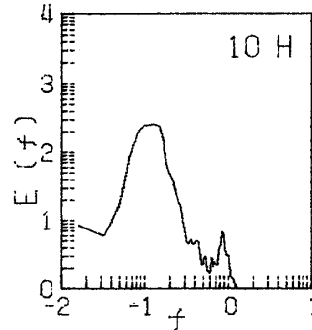
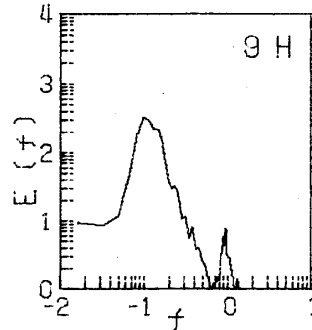
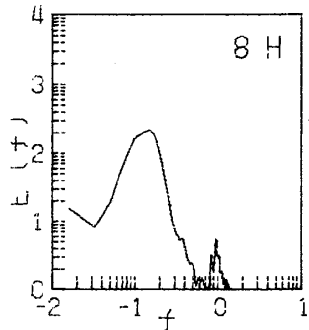
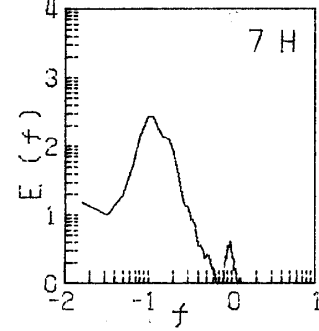
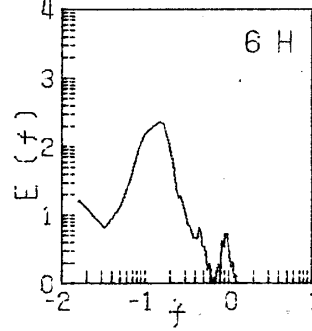
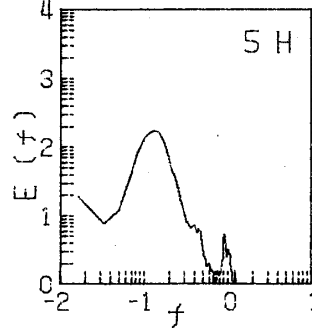
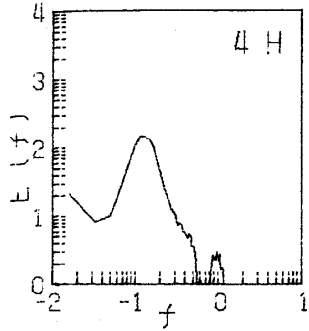
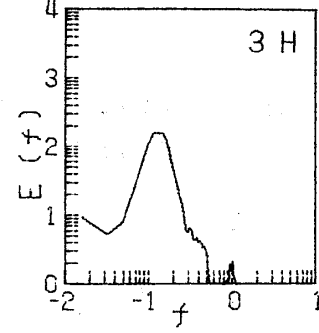
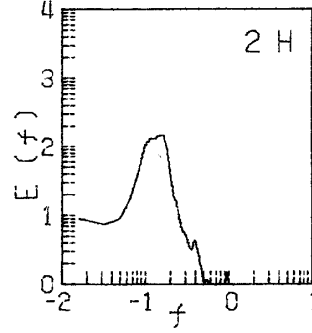
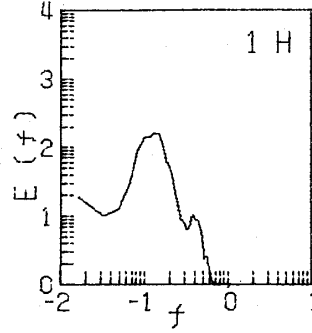
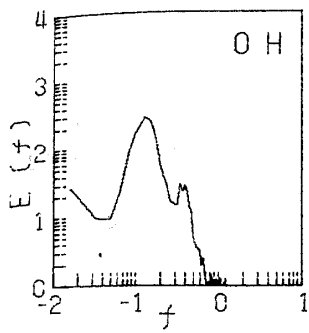

1978 11 22

HOUR	WAVE NUMBER	T (AVE)	H (AVE)	T (1/3)	H (1/3)	T (1/10)	H (1/10)	T (MAX)	H (MAX)
0	191	3.1	15.8	5.9	27.8	8.7	37.5	8.1	57.1
1	208	2.9	14.3	4.6	23.2	6.9	31.1	9.9	48.3
2	205	2.9	11.7	5.0	19.1	7.6	26.6	8.4	35.2
3	209	2.8	9.5	5.3	16.4	8.0	22.6	9.0	27.5
4	137	4.3	14.2	7.9	25.9	9.1	34.3	8.1	42.5
5	183	3.3	10.9	5.5	18.1	7.8	25.0	7.8	35.2
6	139	4.3	13.9	7.6	25.3	9.6	35.8	9.9	45.8
7	156	3.8	15.6	6.6	27.9	8.7	42.4	8.7	59.7
8	167	3.6	15.2	6.5	28.2	8.2	38.3	8.7	47.2
9	138	4.3	20.9	7.2	38.1	8.6	47.8	8.7	58.6
10	142	4.1	20.5	6.8	36.0	8.7	49.9	9.6	76.2
11	162	3.7	18.9	6.5	32.7	8.1	43.9	9.0	68.8
12	152	3.9	23.4	6.6	39.5	8.6	55.0	8.4	67.7
13	136	4.4	23.0	7.8	39.2	8.7	51.4	8.4	66.7
14	118	5.0	25.7	7.8	42.5	7.6	54.0	7.8	72.1
15	125	4.8	23.0	7.1	37.2	7.6	48.3	7.8	56.0
16	135	4.4	27.7	6.8	46.4	8.1	60.1	8.7	87.5
17	118	5.0	32.0	7.8	56.1	8.0	69.3	7.5	86.4
18	115	5.1	28.8	7.9	49.9	8.4	62.7	7.8	107.7
19	102	5.8	30.1	8.5	48.8	8.5	57.4	13.2	65.6
20	108	5.5	28.4	8.1	48.9	8.8	61.0	9.0	70.7
21	115	5.2	23.3	8.9	41.6	9.6	54.0	8.4	70.3
22	113	5.3	23.3	9.0	41.2	9.6	52.9	6.9	62.6
23	138	4.3	21.4	6.9	36.4	8.7	48.1	8.4	60.4

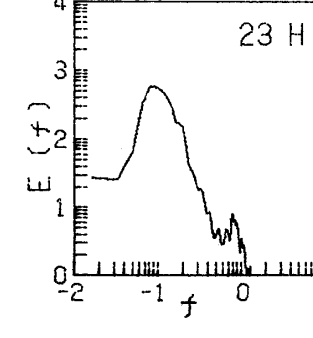
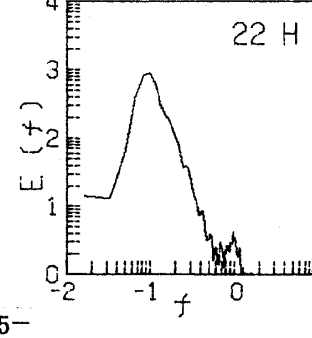
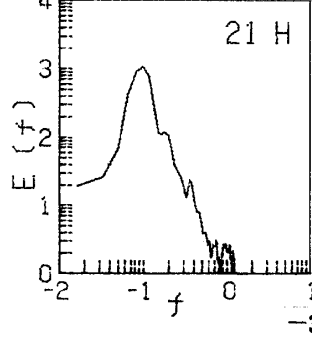
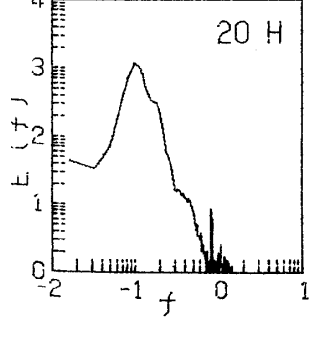
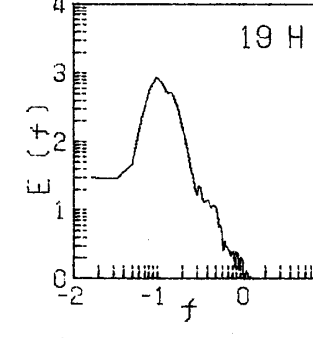
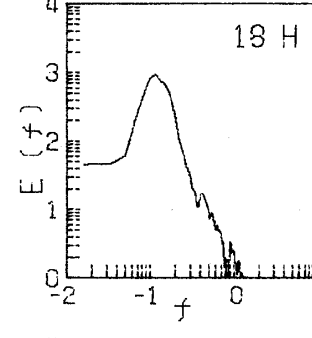
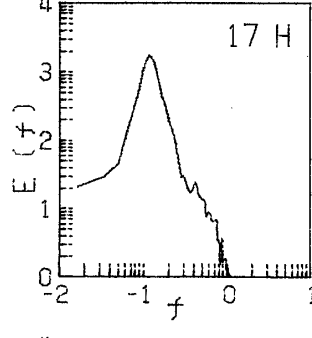
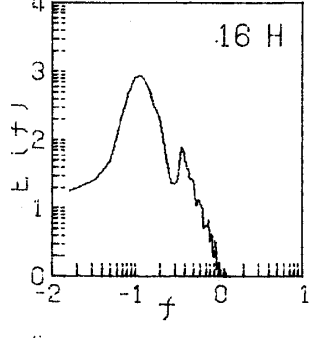
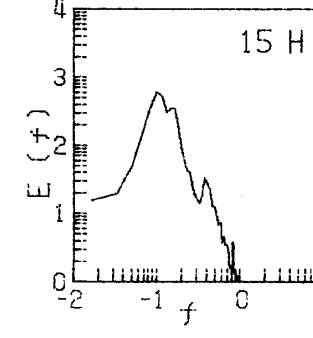
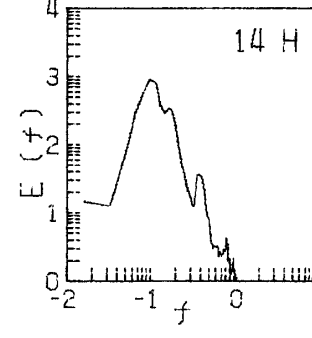
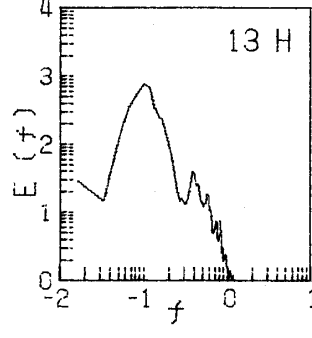
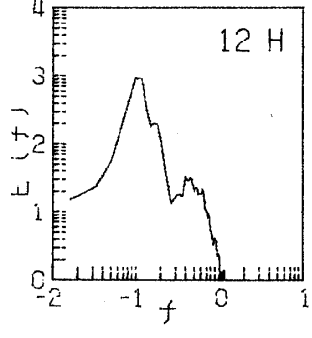
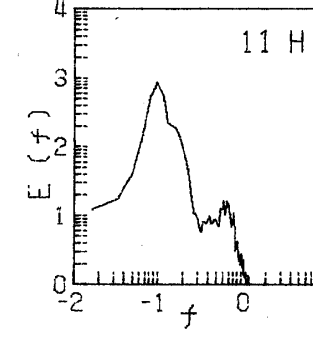
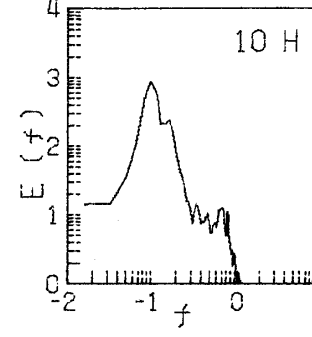
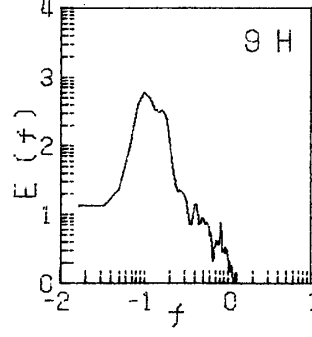
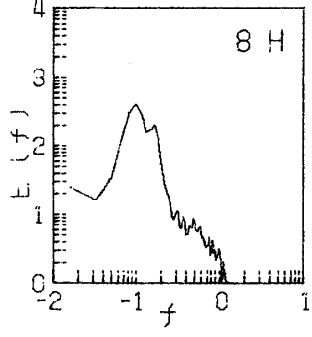
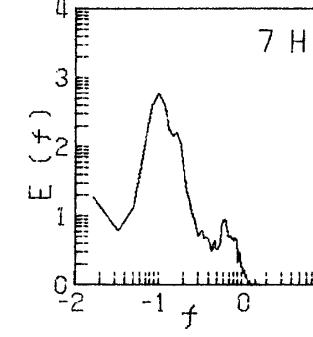
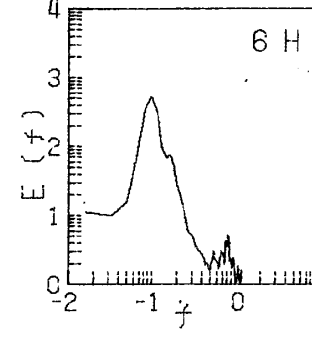
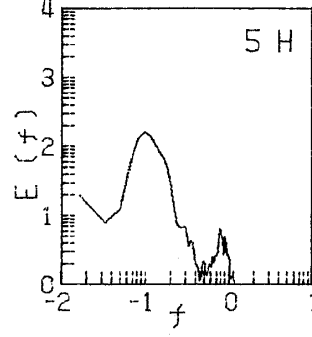
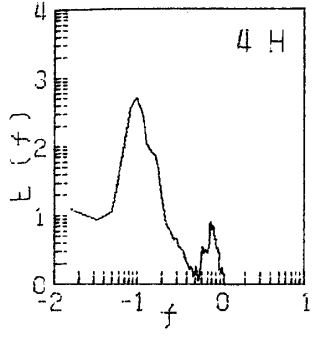
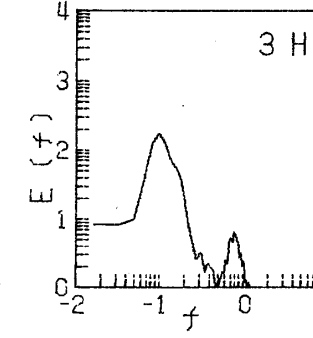
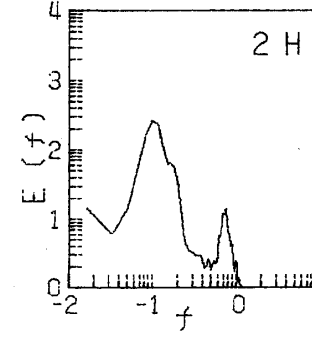
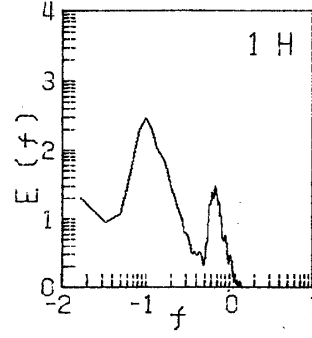
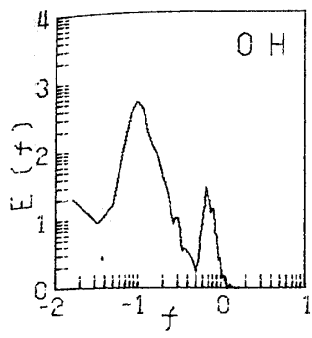

1978 11 23

HOUR	WAVE NUMBER	T (AVE)	H (AVE)	T (1/3)	H (1/3)	T (1/10)	H (1/10)	T (MAX)	H (MAX)
0	132	4.5	19.4	7.7	35.5	9.6	45.7	9.6	61.9
1	108	5.5	23.3	9.2	39.9	11.1	52.1	11.4	63.7
2	115	5.1	19.4	8.3	33.2	9.4	40.1	9.6	46.1
3	133	4.5	18.3	8.2	33.8	10.4	46.8	11.1	64.5
4	127	4.6	19.0	8.3	34.8	10.0	45.1	11.1	53.5
5	117	5.1	20.5	8.6	35.8	10.3	47.1	10.8	61.2
6	96	6.1	24.7	9.2	43.1	10.3	60.2	10.8	78.0
7	99	6.0	25.5	10.1	45.9	10.5	58.5	10.2	76.2
8	92	6.4	29.9	10.2	51.0	10.5	63.5	9.9	76.2
9	95	6.1	32.7	10.4	58.3	9.9	72.3	7.2	79.5
10	90	6.6	32.8	9.1	52.6	9.4	61.9	11.4	67.7
11	103	5.7	28.7	8.8	50.6	9.4	62.7	10.5	77.3
12	95	6.2	29.0	8.7	46.9	9.6	56.9	10.2	65.9
13	115	5.2	23.2	8.5	40.8	8.9	51.8	8.1	62.6
14	117	5.0	22.6	8.4	39.2	8.9	48.5	8.7	69.6
15	118	5.1	24.4	8.2	42.2	9.0	57.0	11.1	74.0
16	110	5.4	27.4	9.1	49.3	9.8	62.8	9.9	71.0
17	124	4.8	23.7	8.4	43.1	9.1	56.8	9.9	78.7
18	130	4.6	21.8	7.8	38.1	8.0	48.5	9.0	60.4
19	125	4.8	23.4	8.2	42.3	9.2	54.0	9.0	64.8
20	119	5.0	24.1	8.2	40.6	8.5	50.5	9.0	54.2
21	117	5.1	24.6	7.2	40.1	7.8	48.5	6.6	63.7
22	133	4.5	20.4	7.5	36.9	8.6	48.8	8.1	57.9
23	118	5.0	21.8	7.5	37.6	9.0	50.6	9.6	58.6

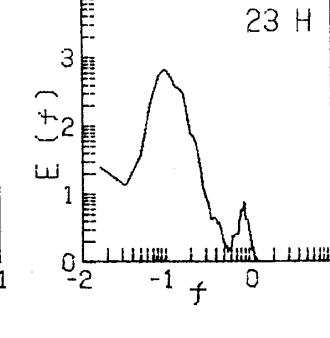
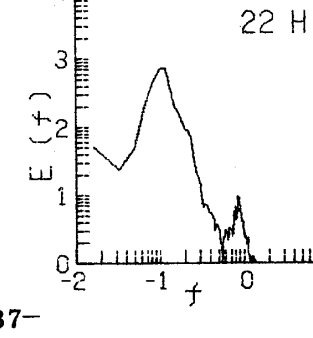
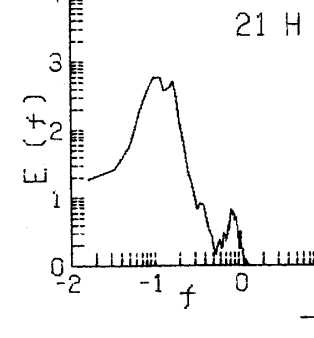
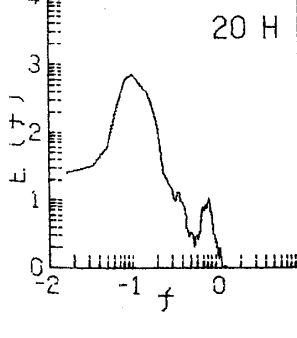
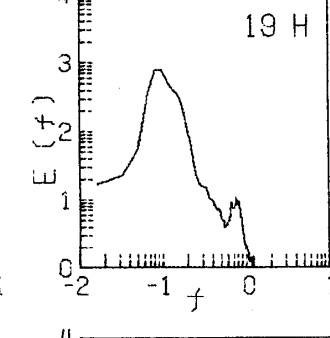
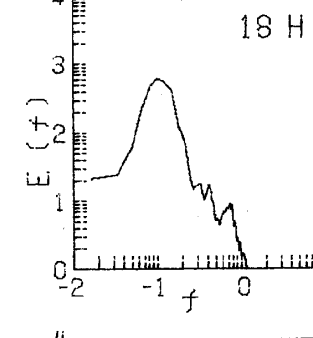
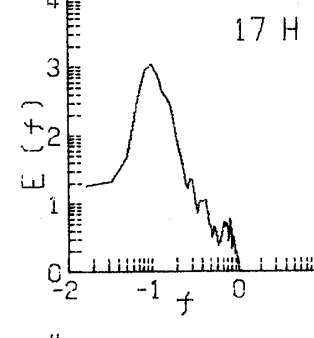
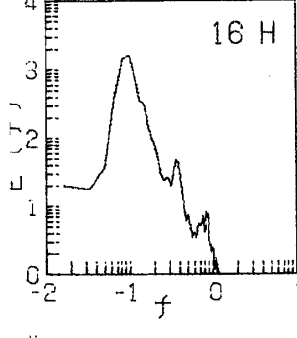
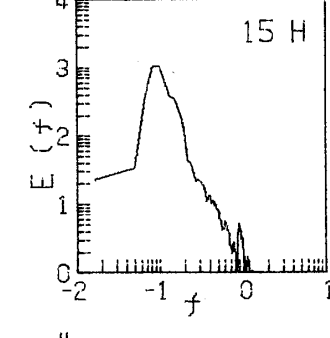
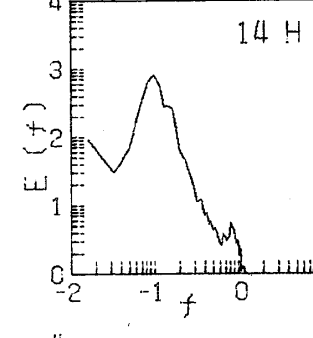
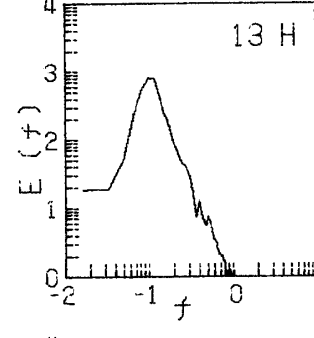
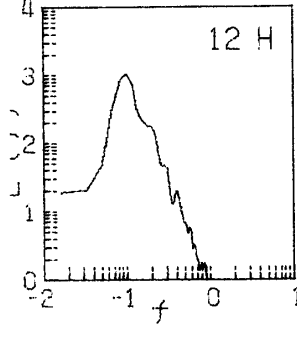
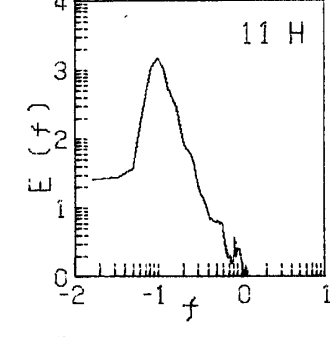
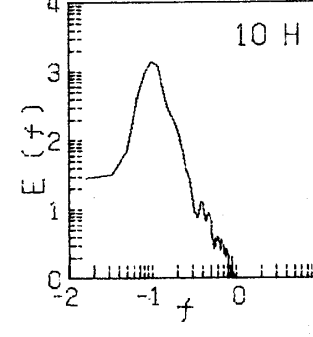
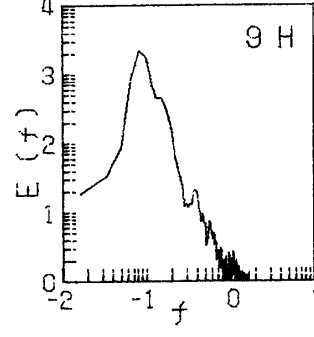
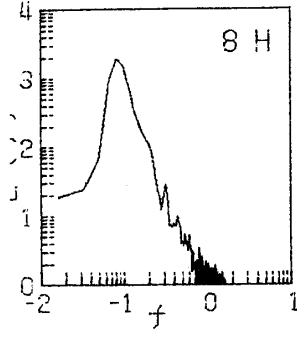
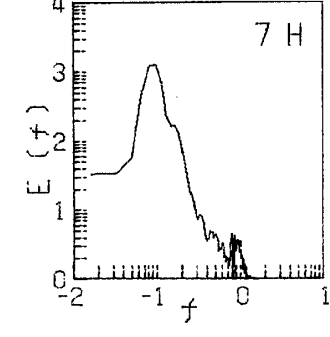
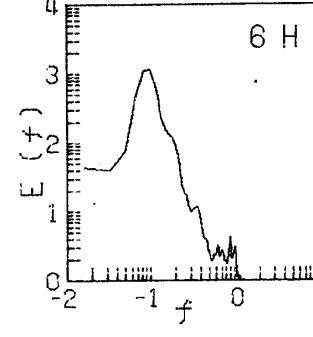
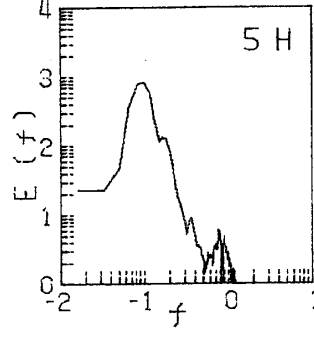
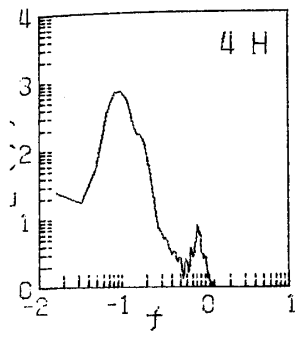
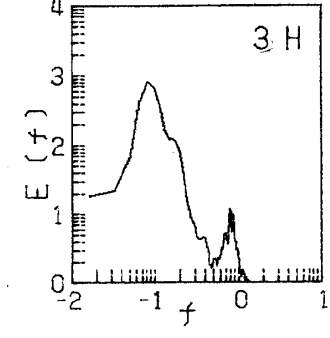
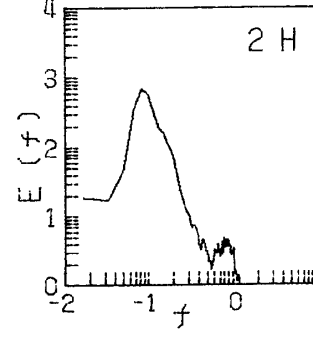
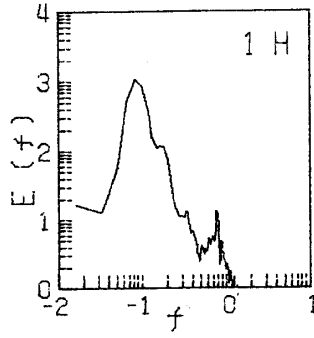
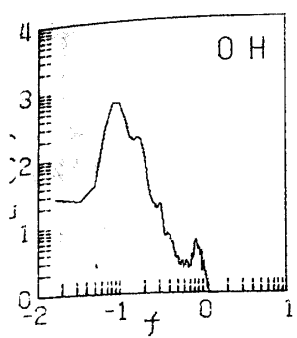

1978 11 24

HOUR	WAVE NUMBER	T (AVE)	H (AVE)	T (1/3)	H (1/3)	T (1/10)	H (1/10)	T (MAX)	H (MAX)
0	109	5.4	21.7	8.2	35.8	8.2	46.1	8.4	53.8
1	145	4.1	17.3	7.3	32.8	8.5	47.1	8.7	57.5
2	138	4.3	16.3	8.0	31.2	9.1	44.6	10.8	67.4
3	129	4.6	20.3	8.4	35.1	10.1	43.1	10.5	54.2
4	153	3.9	14.2	7.5	24.9	9.1	32.8	12.9	41.7
5	124	4.8	19.1	7.8	32.7	8.5	40.6	7.5	48.3
6	110	5.4	23.9	8.6	42.3	8.5	54.5	9.6	60.4
7	122	4.9	22.4	8.2	43.3	9.1	56.5	12.0	68.8
8	110	5.4	27.8	8.1	49.6	8.3	64.4	8.7	84.6
9	110	5.4	34.4	7.8	59.1	7.6	70.7	7.5	84.6
10	120	4.9	31.8	7.5	55.0	7.6	71.3	7.8	100.3
11	111	5.3	35.8	7.7	62.7	8.0	79.1	8.1	87.9
12	136	4.4	29.5	7.3	51.2	7.8	67.0	7.5	87.9
13	164	3.6	27.0	6.5	49.1	7.8	66.7	7.2	87.2
14	135	4.4	32.7	7.3	55.5	8.1	69.9	12.0	83.5
15	117	5.1	38.5	7.7	65.9	7.1	82.6	7.8	111.3
16	112	5.3	45.4	7.8	75.2	7.9	93.8	7.8	119.4
17	115	5.2	39.9	7.7	71.6	8.6	91.5	6.9	104.4
18	109	5.5	33.9	8.4	60.0	8.9	76.0	8.1	87.2
19	97	6.1	37.6	7.8	60.6	8.1	72.7	7.8	81.7
20	104	5.7	36.3	8.0	62.1	8.3	72.4	8.1	78.7
21	101	5.9	37.2	7.7	60.3	8.2	74.1	7.2	87.5
22	104	5.7	36.9	7.8	62.9	7.8	81.5	7.5	103.3
23	115	5.1	32.9	7.7	57.5	8.1	73.8	7.5	93.8

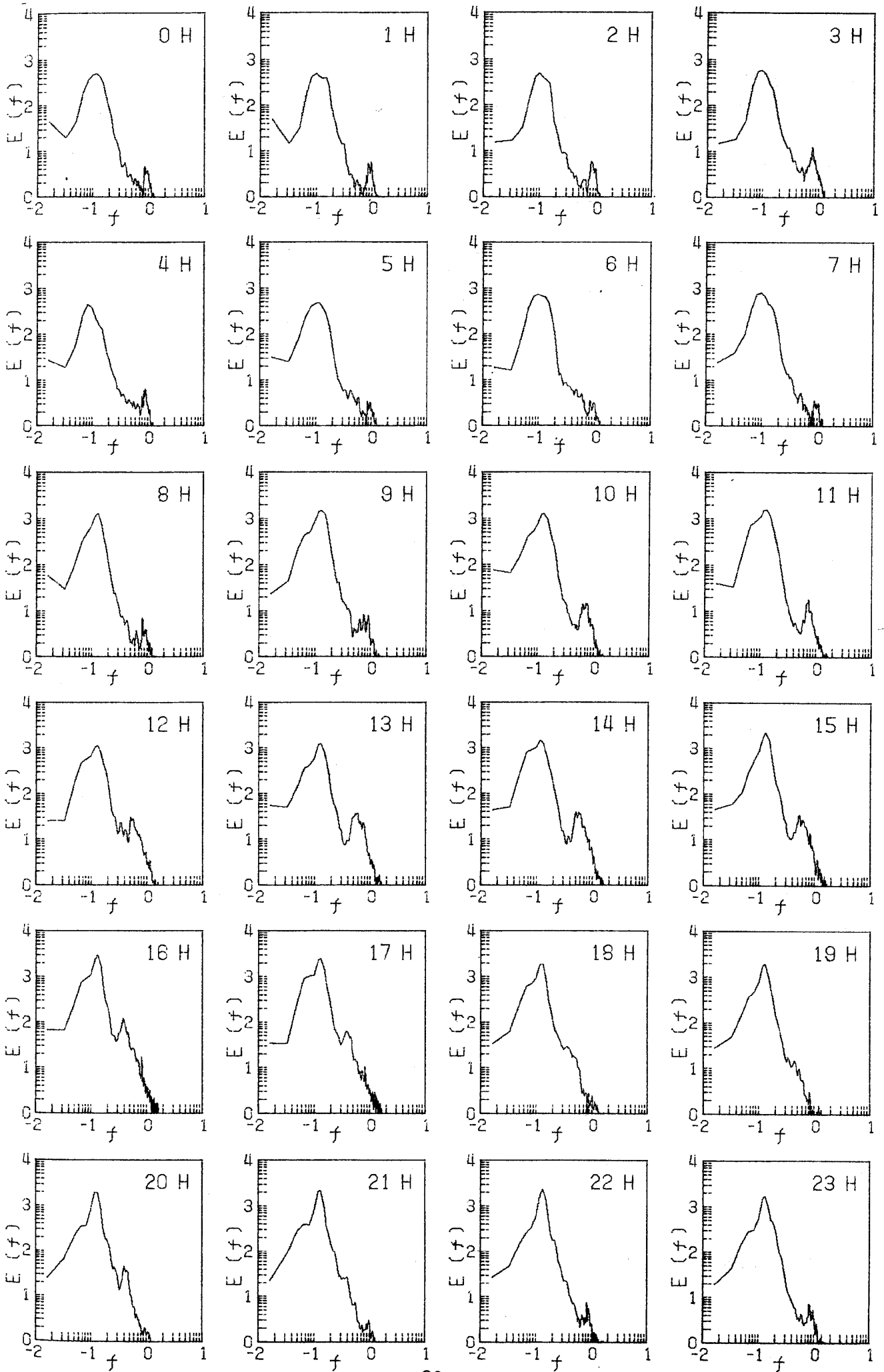

1978 11 25

HOUR	WAVE NUMBER	T (AVE)	H (AVE)	T (1/3)	H (1/3)	T (1/10)	H (1/10)	T (MAX)	H (MAX)
0	120	4.9	31.5	7.6	53.7	7.7	66.2	8.1	82.8
1	113	5.2	29.5	7.8	51.4	9.4	64.5	9.3	80.6
2	121	4.9	23.5	7.8	41.6	8.4	52.4	10.2	70.3
3	107	5.6	24.2	8.1	41.9	8.7	54.0	7.8	60.1
4	116	5.1	18.9	8.7	35.0	8.6	45.1	9.9	56.8
5	110	5.4	21.3	9.4	38.6	10.6	46.4	8.4	52.0
6	108	5.5	22.6	8.1	38.0	9.3	48.9	7.8	59.3
7	122	4.8	17.5	8.8	32.1	10.7	40.2	13.2	50.9
8	100	5.9	26.2	9.6	46.1	12.3	58.0	12.9	71.0
9	100	5.9	25.0	9.4	44.6	9.4	59.1	8.1	78.0
10	128	4.7	24.8	7.6	44.0	9.1	58.1	8.4	74.7
11	117	5.1	28.4	8.0	50.4	8.9	62.3	9.3	78.4
12	112	5.3	29.0	8.2	50.8	8.7	63.8	8.7	101.8
13	117	5.1	25.2	8.1	42.9	8.9	53.4	6.9	63.7
14	123	4.8	23.5	8.2	42.8	8.3	54.8	9.0	63.7
15	125	4.7	26.2	7.7	44.6	8.0	57.2	8.7	64.8
16	105	5.7	32.5	8.2	52.9	8.3	64.7	7.8	72.9
17	110	5.4	26.6	8.0	46.9	8.6	58.2	6.9	65.6
18	113	5.3	25.2	7.6	43.9	7.9	55.9	7.8	65.6
19	128	4.7	20.4	7.2	35.0	7.7	42.1	6.9	52.0
20	129	4.6	19.1	6.9	31.5	7.3	39.0	7.2	46.5
21	134	4.4	17.6	6.9	30.1	7.1	38.8	8.1	57.9
22	127	4.7	17.5	6.8	29.6	7.3	38.6	7.5	44.3
23	144	4.1	18.0	6.9	32.7	7.2	43.4	8.4	56.8

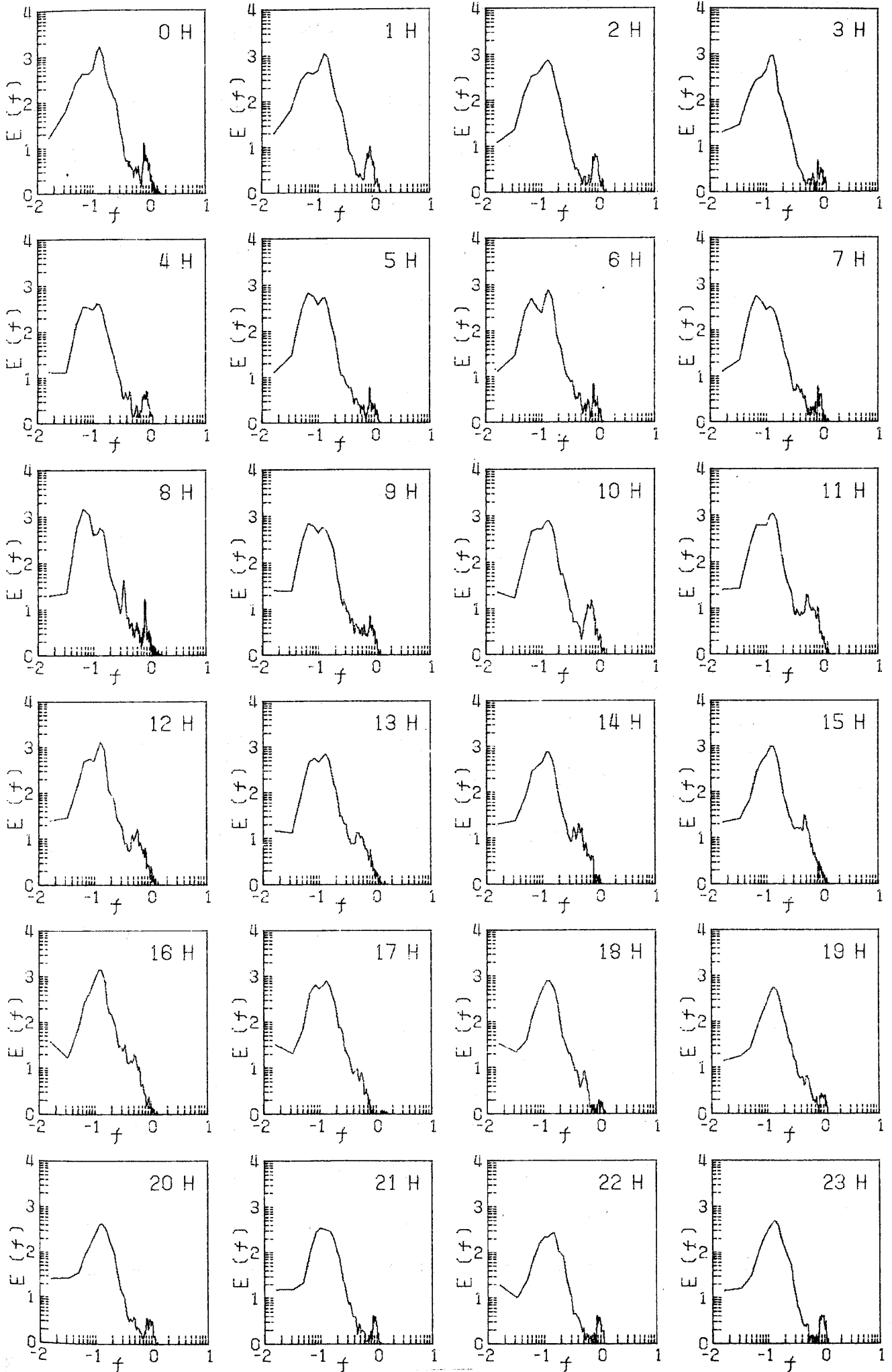

1978 11 26

HOUR	WAVE NUMBER	T (AVE)	H (AVE)	T (1/3)	H (1/3)	T (1/10)	H (1/10)	T (MAX)	H (MAX)
0	118	5.0	24.0	7.4	39.2	7.3	48.4	7.2	61.9
1	130	4.6	21.1	7.2	35.1	7.4	43.0	7.2	50.9
2	120	4.9	19.5	8.1	34.4	8.7	44.9	9.0	48.7
3	163	3.6	15.1	6.4	26.7	7.7	35.6	6.9	44.3
4	142	4.2	16.8	7.6	30.7	9.0	42.0	7.5	54.2
5	124	4.8	16.0	7.8	27.3	8.5	36.1	7.8	50.5
6	129	4.6	15.7	7.5	27.3	8.6	36.4	8.4	46.1
7	128	4.6	17.0	7.9	31.4	8.8	41.0	7.8	47.2
8	133	4.5	17.0	7.8	30.4	8.5	39.4	8.7	49.1
9	142	4.2	17.2	7.1	32.1	8.0	43.2	6.9	56.4
10	125	4.8	18.7	8.0	32.2	8.1	39.3	8.7	48.0
11	137	4.3	19.3	7.2	34.8	7.7	44.4	7.8	53.5
12	133	4.5	18.6	7.7	34.1	8.0	43.4	9.3	58.2
13	124	4.8	21.0	7.6	37.1	7.8	45.8	8.7	53.8
14	139	4.3	19.4	7.5	34.7	8.4	45.4	9.6	56.4
15	151	4.0	17.8	6.7	31.9	7.9	40.6	7.2	47.6
16	154	3.9	20.4	6.2	33.8	7.7	43.8	9.9	57.1
17	152	3.9	15.6	6.8	27.0	7.6	35.3	7.2	49.8
18	130	4.6	15.5	7.5	27.0	8.4	34.6	9.0	38.5
19	148	4.0	12.7	6.9	21.0	7.0	25.1	8.1	28.9
20	120	4.9	10.7	7.3	19.2	8.3	25.3	8.4	31.9
21	97	6.1	13.1	9.4	21.7	9.1	26.2	9.0	30.8
22	115	5.2	14.5	8.0	23.9	8.2	28.7	8.7	35.9
23	112	5.3	18.0	8.0	31.3	8.3	38.9	7.5	46.9

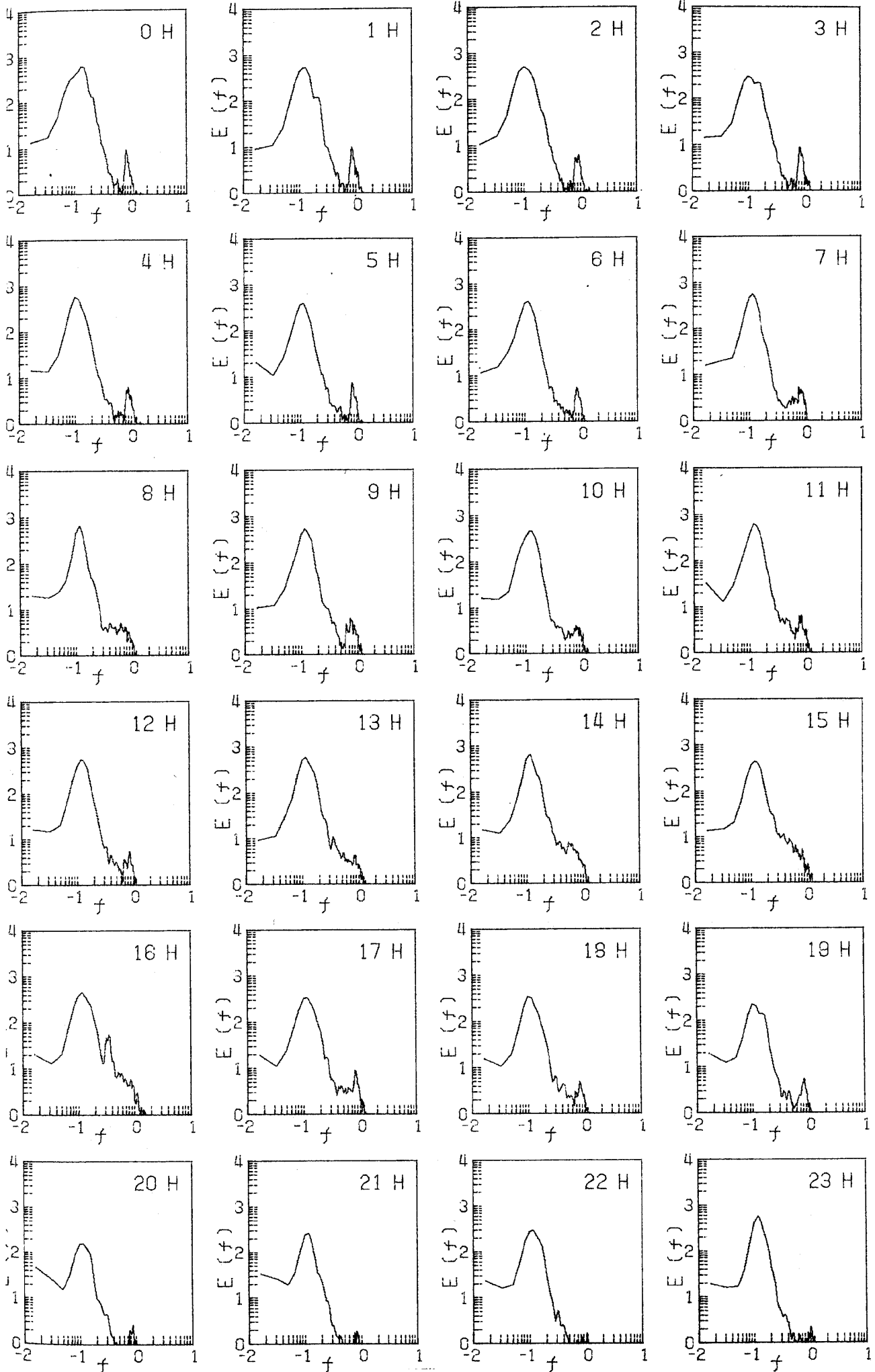

1978 11 27

HOUR	WAVE NUMBER	T (AVE)	H (AVE)	T (1/3)	H (1/3)	T (1/10)	H (1/10)	T (MAX)	H (MAX)
0	124	4.8	17.7	7.9	33.5	8.3	46.6	8.7	75.1
1	123	4.8	18.6	7.2	33.3	7.2	44.1	8.1	60.8
2	99	6.0	21.2	7.7	35.5	7.4	44.3	6.3	50.5
3	125	4.7	19.8	7.5	35.3	7.3	47.5	6.9	67.7
4	164	3.6	15.8	6.5	29.5	7.8	41.2	7.2	55.3
5	126	4.7	20.1	7.4	35.3	7.4	45.9	8.4	57.9
6	136	4.4	17.4	7.9	32.0	8.2	42.7	8.1	55.7
7	111	5.3	17.9	8.3	32.6	9.0	45.7	7.5	62.3
8	109	5.4	24.9	7.7	44.1	7.9	55.0	6.9	66.3
9	95	6.3	30.3	7.7	49.0	7.4	59.4	6.6	72.5
10									
11									
12	112	5.3	32.4	7.8	56.7	8.0	69.9	7.2	81.3
13	123	4.8	32.1	7.6	57.2	8.7	73.6	7.8	91.9
14	113	5.2	28.8	7.9	51.7	7.8	68.4	8.1	81.7
15	124	4.8	33.7	7.6	58.9	7.9	73.3	7.5	88.6
16	118	5.0	32.6	7.5	54.5	8.1	71.4	8.7	85.7
17									
18									
19									
20	103	5.8	16.4	8.5	27.5	8.7	32.3	8.4	37.7
21	93	6.3	12.5	8.7	21.2	9.5	26.1	9.6	29.3
22	99	6.0	14.2	8.4	24.1	9.4	33.9	8.1	46.9
23	97	6.1	20.4	8.5	32.4	8.5	39.7	8.7	47.6

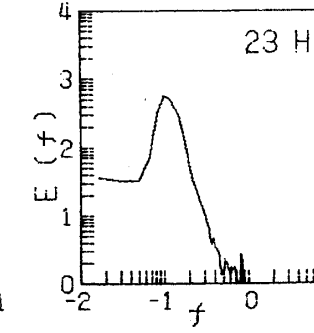
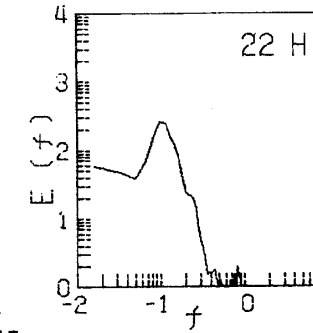
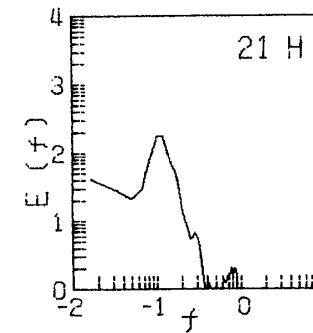
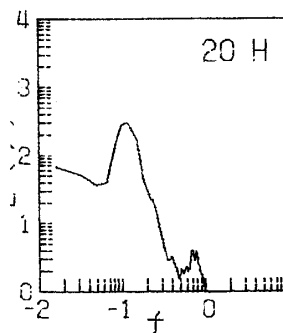
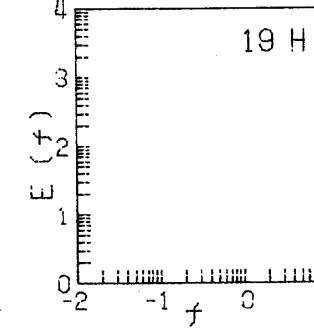
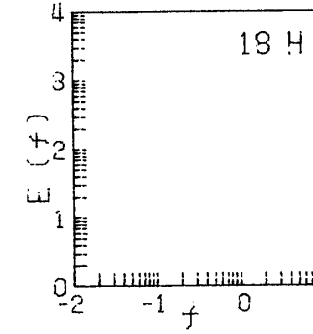
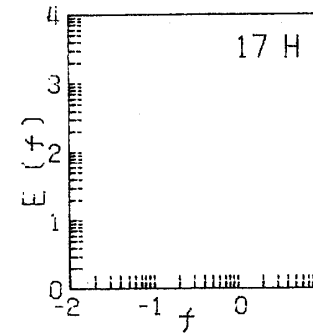
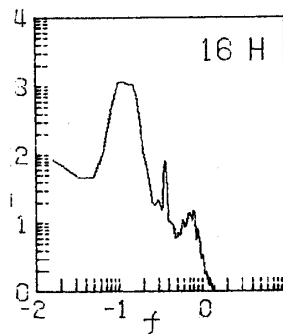
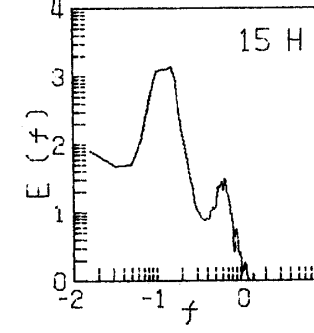
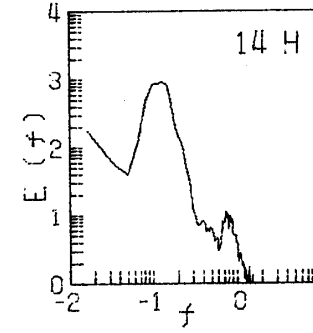
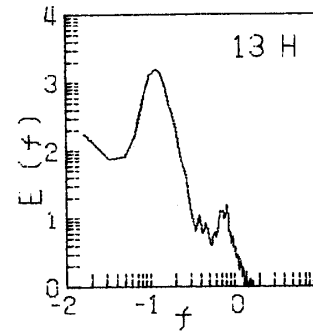
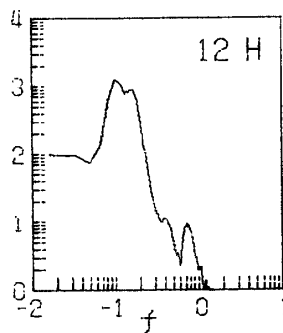
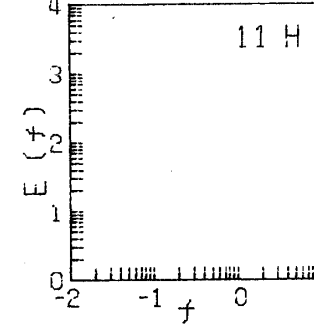
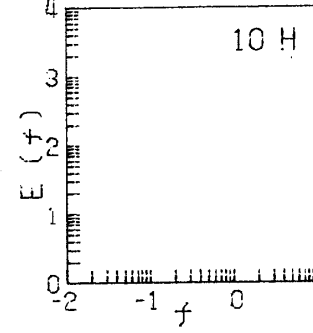
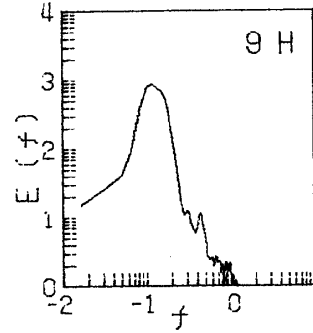
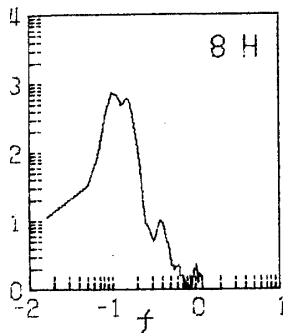
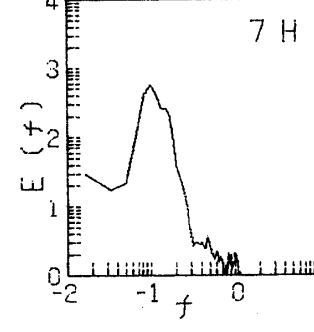
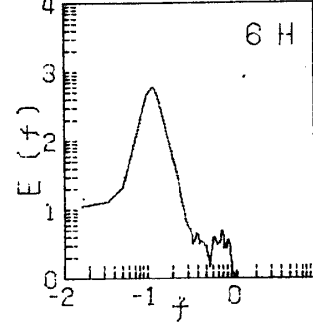
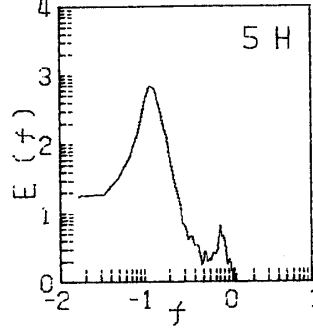
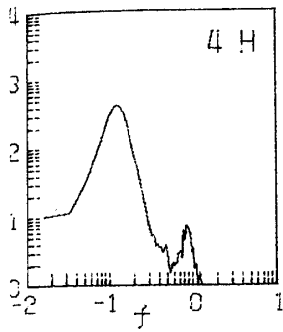
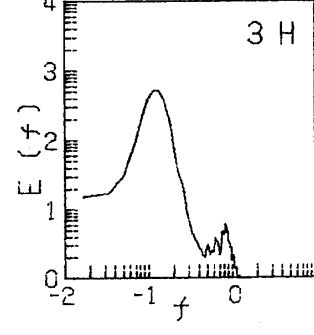
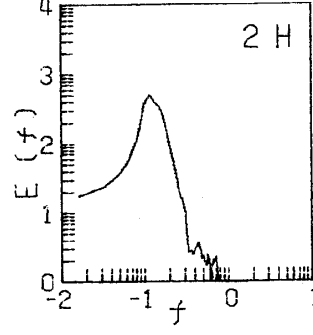
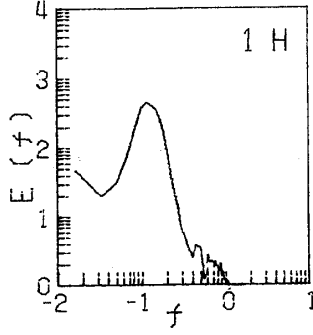
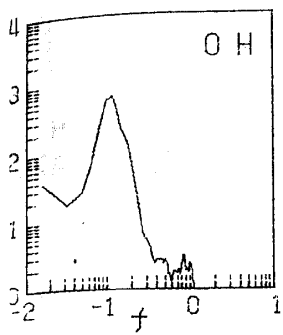

1978 11 28

HOUR	WAVE NUMBER	T (AVE)	H (AVE)	T (1/3)	H (1/3)	T (1/10)	H (1/10)	T (MAX)	H (MAX)
0	105	5.7	24.0	8.4	42.5	8.9	52.7	8.1	59.7
1	97	6.1	30.6	8.7	52.6	8.2	68.2	7.8	88.3
2	91	6.5	41.6	8.4	72.1	8.4	85.0	8.1	99.6
3	93	6.4	37.5	8.5	65.3	8.9	79.9	7.5	98.1
4	100	5.9	32.3	7.9	54.2	7.8	67.5	7.5	79.8
5	107	5.6	28.7	8.6	52.4	8.3	67.3	7.5	90.1
6	96	6.2	36.7	8.7	61.2	9.2	79.5	10.2	87.5
7	88	6.7	42.4	8.9	69.2	9.0	81.9	9.3	98.1
8	92	6.4	40.1	8.8	67.6	8.1	86.4	7.8	103.3
9	93	6.4	39.1	8.0	60.8	8.1	75.3	8.4	107.7
10	99	6.0	40.1	7.9	67.1	7.9	78.9	8.7	91.9
11	131	4.5	41.3	6.8	70.2	7.7	89.9	7.8	127.4
12	157	3.8	62.1	4.9	93.2	5.2	117.5	4.5	154.5
13	151	3.9	78.6	4.9	120.1	4.8	141.7	3.3	165.5
14	159	3.7	83.3	4.8	128.6	5.2	159.3	4.2	196.3
15	141	4.2	109.3	5.2	163.8	5.2	193.2	5.7	241.0
16	148	4.0	94.0	5.3	147.3	5.2	178.4	4.8	241.0
17	137	4.4	91.6	5.5	143.4	5.6	181.8	5.4	218.6
18	131	4.6	70.1	5.7	114.7	5.9	143.8	4.5	206.9
19	142	4.2	62.8	5.2	106.3	5.4	133.9	6.3	154.2
20	128	4.6	48.6	5.2	84.2	5.1	113.6	4.8	169.2
21	140	4.2	43.8	5.0	81.7	5.0	114.2	4.8	157.5
22	127	4.7	53.1	5.4	95.0	5.6	135.5	4.8	188.2
23	128	4.7	48.6	5.7	85.3	5.7	116.5	5.1	147.9

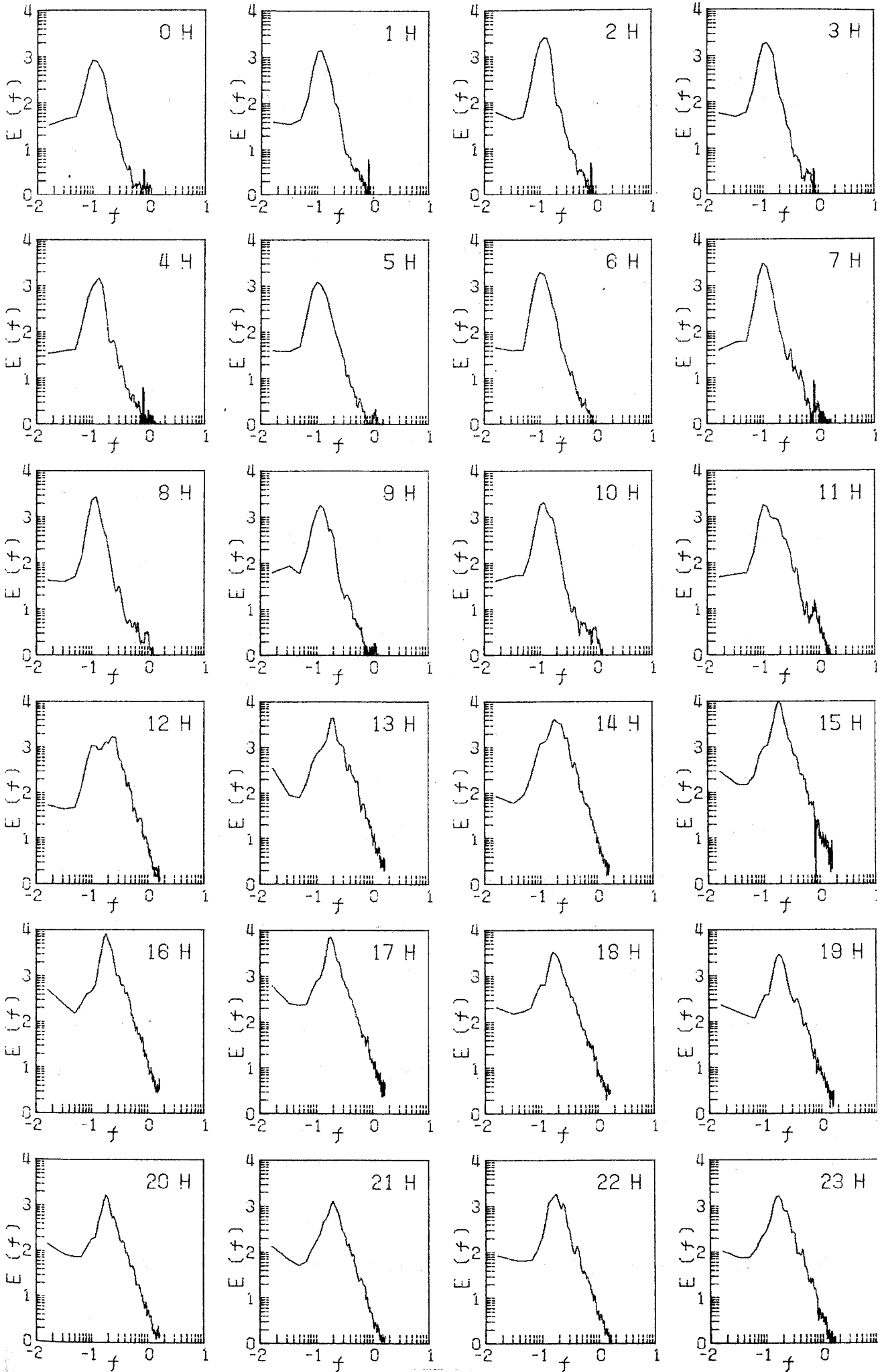

1978 11 29

HOUR	WAVE NUMBER	T (AVE)	H (AVE)	T (1/3)	H (1/3)	T (1/10)	H (1/10)	T (MAX)	H (MAX)
0	131	4.5	58.6	5.5	92.9	5.4	116.7	6.6	146.9
1	148	4.0	64.7	5.3	104.9	5.9	134.8	4.5	180.2
2	138	4.3	96.1	5.4	140.1	5.4	160.4	4.5	190.1
3	139	4.3	85.6	6.0	135.8	6.0	167.3	4.8	221.6
4	122	4.9	85.9	6.5	133.5	7.1	165.6	6.3	184.6
5	127	4.7	81.7	5.9	124.6	6.7	156.2	6.3	193.7
6	119	5.0	104.2	6.6	168.2	7.0	208.5	5.1	250.5
7	103	5.7	106.7	6.9	156.1	6.6	187.1	6.6	224.1
8	108	5.4	88.4	6.6	135.6	6.7	159.9	6.6	172.5
9	109	5.5	80.2	6.5	117.0	6.4	136.0	7.5	144.3
10	121	4.9	68.3	6.1	107.7	6.8	134.1	5.4	156.7
11	111	5.3	88.5	6.3	129.1	6.2	156.2	6.3	172.1
12	125	4.8	86.2	6.1	130.8	5.9	157.4	5.4	172.1
13	128	4.7	81.2	5.8	125.6	5.9	149.5	5.4	185.7
14	154	3.9	77.3	5.1	122.1	5.0	149.2	5.7	180.9
15	154	3.9	73.3	4.8	113.0	4.5	136.9	3.9	160.4
16	160	3.7	64.5	5.0	98.8	5.4	117.3	3.3	141.4
17	147	4.0	55.0	5.0	85.1	4.8	103.8	5.7	124.5
18	134	4.4	49.2	5.7	78.2	6.4	97.7	6.6	119.0
19	108	5.4	39.8	6.8	58.0	7.1	67.4	7.2	73.6
20	96	6.2	27.9	7.5	47.1	7.0	59.5	6.0	70.7
21	103	5.8	15.3	7.7	26.9	7.7	38.7	7.8	52.0
22	99	6.0	18.6	7.9	29.1	7.9	37.6	9.9	44.7
23	90	6.6	17.9	7.8	28.7	7.5	38.6	7.2	46.5

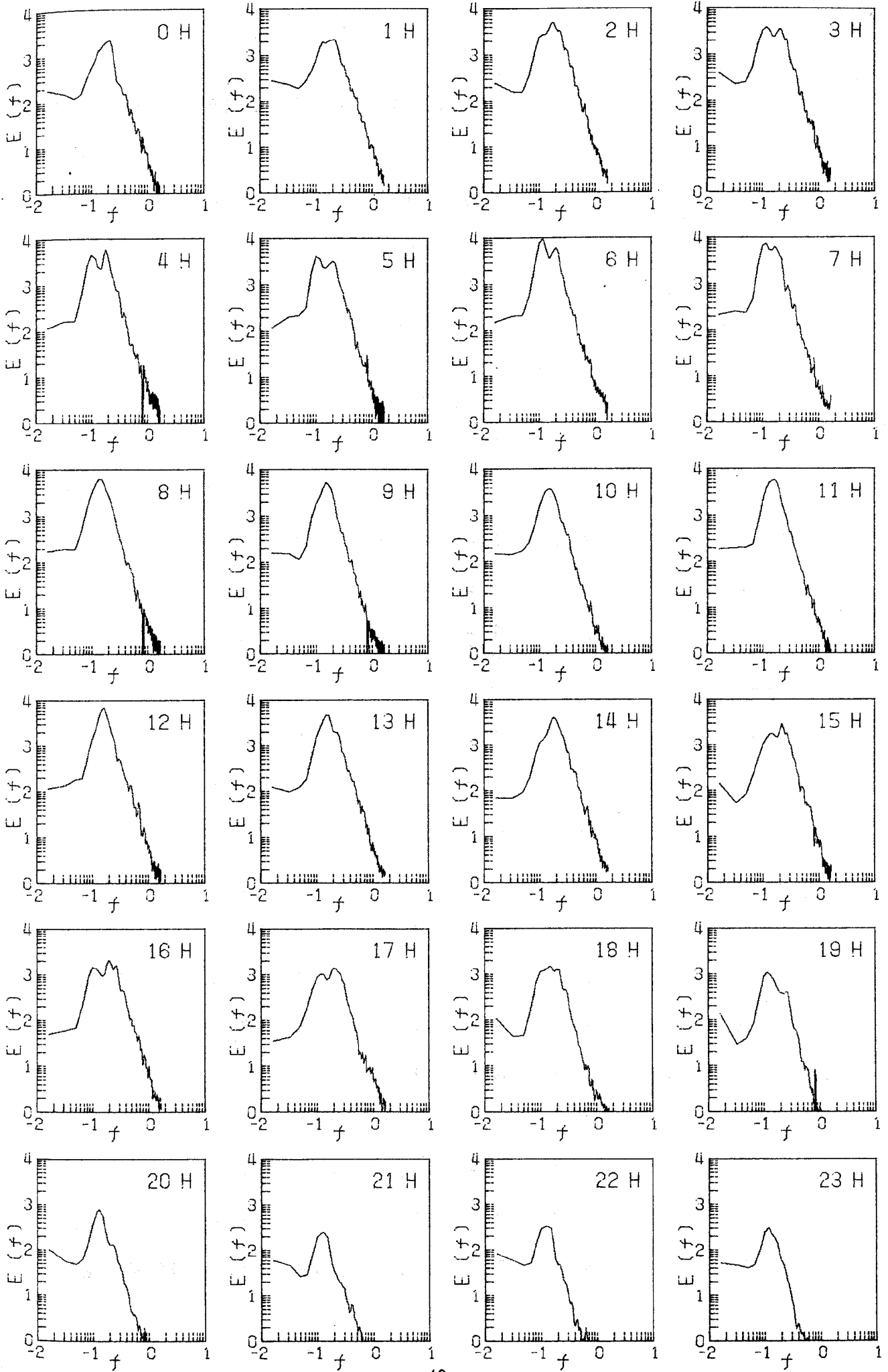

1978 11 30

HOUR	WAVE NUMBER	T (AVE)	H (AVE)	T (1/3)	H (1/3)	T (1/10)	H (1/10)	T (MAX)	H (MAX)
0	77	7.5	19.5	8.1	35.2	7.9	47.4	8.1	71.8
1	93	6.4	31.9	7.9	49.3	7.8	63.6	8.1	77.3
2	95	6.2	37.9	8.1	61.7	7.6	76.1	7.8	99.6
3	115	5.2	35.2	6.9	55.8	6.6	69.3	6.0	77.3
4	104	5.7	29.7	8.0	48.3	8.9	58.0	7.5	79.8
5	123	4.9	27.0	7.9	51.7	8.5	66.3	7.8	82.8
6	135	4.4	23.2	7.2	40.8	8.2	57.1	8.7	96.7
7	144	4.1	23.6	7.0	42.7	8.1	58.1	7.2	78.0
8	134	4.5	24.2	7.4	43.9	8.0	58.2	6.6	72.9
9	136	4.3	18.5	6.9	31.2	7.8	38.2	8.4	45.0
10	119	5.0	17.1	7.2	27.3	7.6	33.7	6.0	39.9
11	141	4.2	14.6	6.6	24.8	7.3	32.3	6.6	46.5
12	142	4.2	20.8	7.2	36.0	8.3	45.0	8.4	59.0
13	138	4.3	21.0	6.9	34.0	7.5	40.8	6.6	50.5
14	138	4.3	22.4	6.8	37.3	7.9	49.1	8.1	61.2
15	150	3.9	25.4	6.5	44.2	7.4	56.2	7.2	66.7
16	160	3.7	25.5	5.8	41.2	7.3	54.4	7.8	69.2
17	156	3.8	26.1	5.8	43.2	7.3	56.4	8.1	89.4
18	158	3.7	26.7	5.5	42.2	5.8	53.3	6.3	66.3
19	135	4.3	21.6	6.5	33.5	6.9	40.7	6.9	47.2
20	108	5.5	7.7	8.0	13.3	10.1	18.5	5.4	25.3
21	124	4.8	5.7	7.5	9.1	8.6	11.6	6.3	15.7
22	129	4.6	9.7	7.6	15.0	8.5	18.1	9.6	21.2
23	127	4.7	9.1	7.5	14.9	10.2	18.1	15.6	20.9

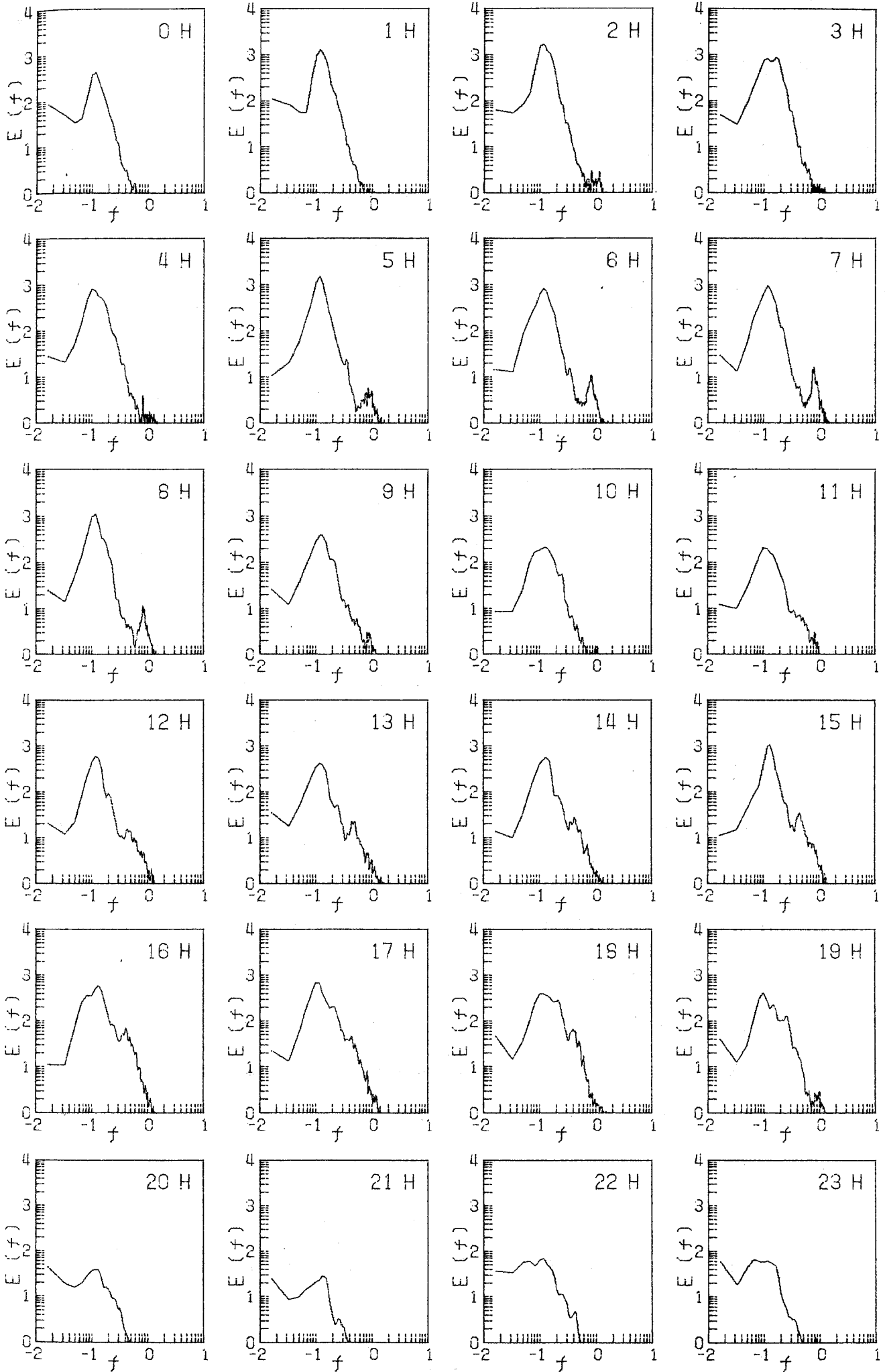

1978 12 01

HOUR	WAVE NUMBER	T (AVE)	H (AVE)	T (1/3)	H (1/3)	T (1/10)	H (1/10)	T (MAX)	H (MAX)
0	120	5.0	6.5	9.2	11.2	11.2	14.2	18.0	20.5
1	124	4.7	3.8	8.8	6.4	12.6	8.8	13.5	14.6
2	97	6.0	13.7	10.6	23.4	15.1	31.4	14.7	38.5
3	92	6.3	26.1	12.3	51.3	15.5	70.0	14.4	79.5
4	110	5.4	23.7	10.0	44.3	13.3	60.5	14.4	80.9
5	99	5.9	25.8	11.5	50.1	13.9	70.0	15.6	88.3
6	90	6.5	31.6	12.7	63.5	14.3	86.8	13.8	113.9
7	76	7.9	38.2	13.5	70.9	14.6	91.9	14.7	105.5
8	70	8.3	40.2	14.2	73.4	14.5	91.6	14.4	113.5
9	116	5.1	22.8	9.7	44.7	12.7	65.9	13.2	81.7
10	97	6.0	22.7	11.6	42.2	13.4	53.8	13.5	60.4
11	94	6.3	23.3	10.7	41.4	12.7	56.2	12.0	75.8
12	75	7.8	29.3	12.3	50.2	12.8	58.9	12.3	62.3
13	104	5.6	20.9	9.9	35.5	12.8	46.2	12.6	57.9
14	117	5.0	22.0	8.5	38.1	11.3	49.2	10.2	59.7
15	119	5.0	25.6	8.1	43.5	9.6	55.2	8.4	64.5
16	107	5.5	27.3	9.0	47.3	11.0	59.3	11.7	74.7
17	132	4.5	24.2	7.3	41.1	9.6	52.3	6.9	61.5
18	121	4.9	26.6	8.3	44.9	11.0	58.0	12.0	69.6
19	113	5.3	24.2	8.9	40.4	11.5	49.3	10.5	59.7
20	81	7.2	24.6	10.9	38.5	11.1	46.2	9.9	49.4
21	95	6.1	5.5	9.0	8.6	10.2	11.8	9.9	16.1
22	90	6.6	10.4	11.1	17.7	11.6	21.4	9.0	24.9
23	92	6.5	10.4	9.2	17.9	9.4	21.5	7.5	29.7

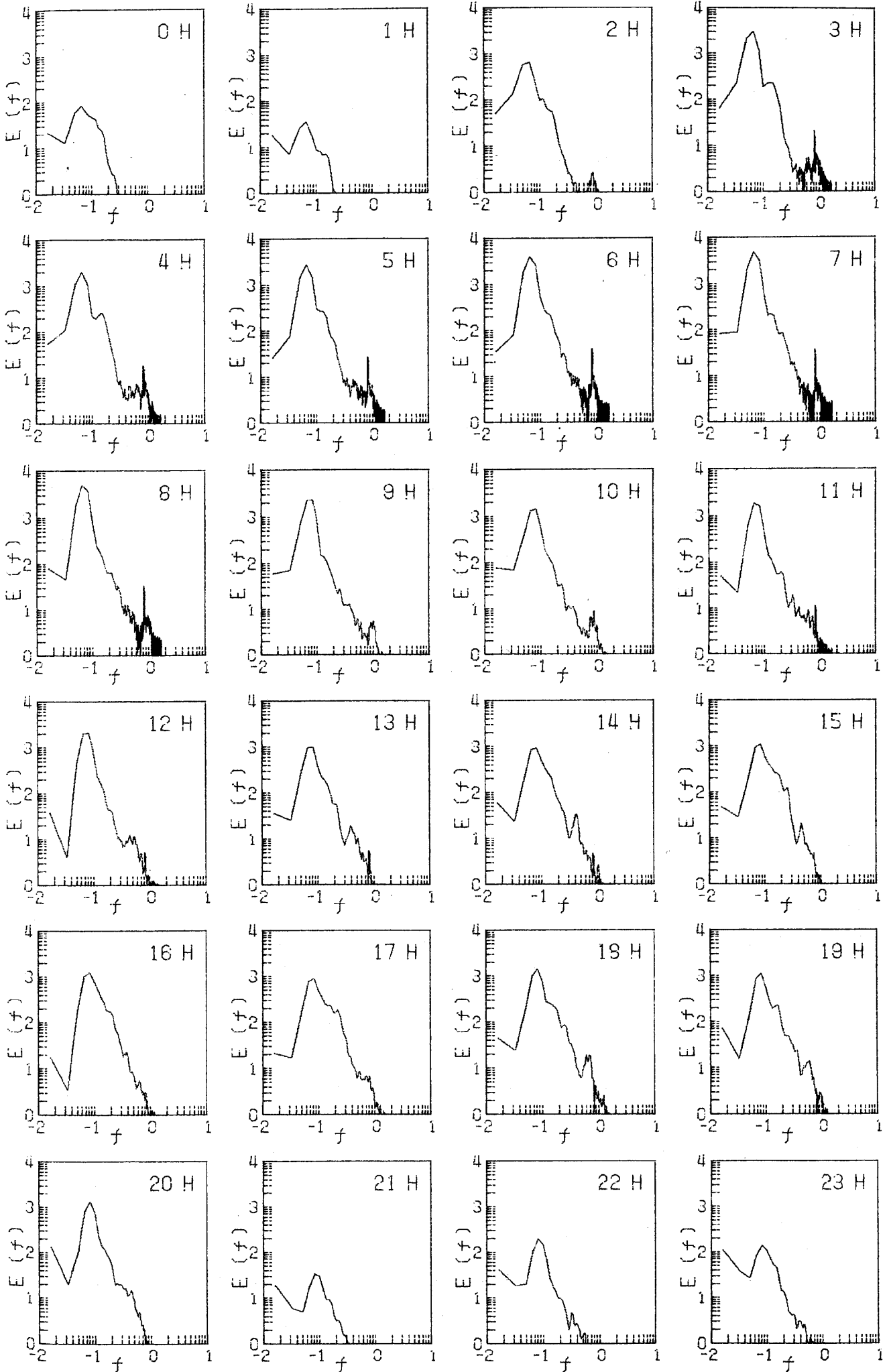

1978 12 02

HOUR	WAVE NUMBER	T (AVE)	H (AVE)	T (1/3)	H (1/3)	T (1/10)	H (1/10)	T (MAX)	H (MAX)
0	106	5.6	9.4	8.9	15.0	9.0	18.8	10.2	23.8
1	125	4.6	6.7	7.5	10.9	8.6	13.4	9.9	15.7
2	134	4.4	6.7	7.6	11.5	8.9	15.6	11.4	20.9
3	194	3.1	26.3	3.8	38.5	4.4	46.4	7.2	53.8
4	169	3.5	28.6	5.0	42.8	6.3	52.3	7.8	65.2
5	164	3.6	27.0	5.2	41.4	6.0	50.0	9.9	59.7
6	195	3.1	24.2	4.6	39.5	6.4	52.5	10.2	75.1
7	188	3.2	25.5	5.1	39.7	6.5	50.4	10.2	68.8
8	205	2.9	29.8	4.0	44.3	5.8	56.0	11.4	78.0
9	195	3.1	36.8	3.9	56.4	4.7	68.0	3.9	76.9
10	181	3.3	53.0	3.8	78.5	3.7	95.7	3.6	123.8
11	181	3.3	47.9	3.7	71.1	3.6	88.7	3.3	118.7
12	180	3.3	43.6	4.0	65.0	3.9	78.5	3.6	98.5
13	173	3.4	47.0	4.7	72.3	4.7	87.6	6.6	115.7
14	161	3.7	65.6	5.0	105.7	4.9	124.9	4.8	141.4
15	162	3.7	63.5	4.8	100.6	4.8	127.9	5.1	157.1
16	139	4.3	83.7	4.8	126.0	4.7	162.0	4.8	188.6
17	147	4.0	76.9	5.0	119.1	4.9	139.4	5.1	168.1
18	166	3.6	62.2	4.7	96.6	4.8	121.4	4.5	154.9
19	143	4.1	56.4	5.2	88.3	5.2	110.0	5.4	147.2
20	142	4.2	49.3	5.2	74.2	5.5	87.1	6.6	95.6
21	141	4.2	30.2	5.6	47.2	5.3	62.2	5.1	95.6
22	128	4.7	16.4	5.8	27.0	5.6	38.3	6.3	53.5
23	115	5.2	23.5	5.9	33.6	5.0	44.8	4.5	100.7

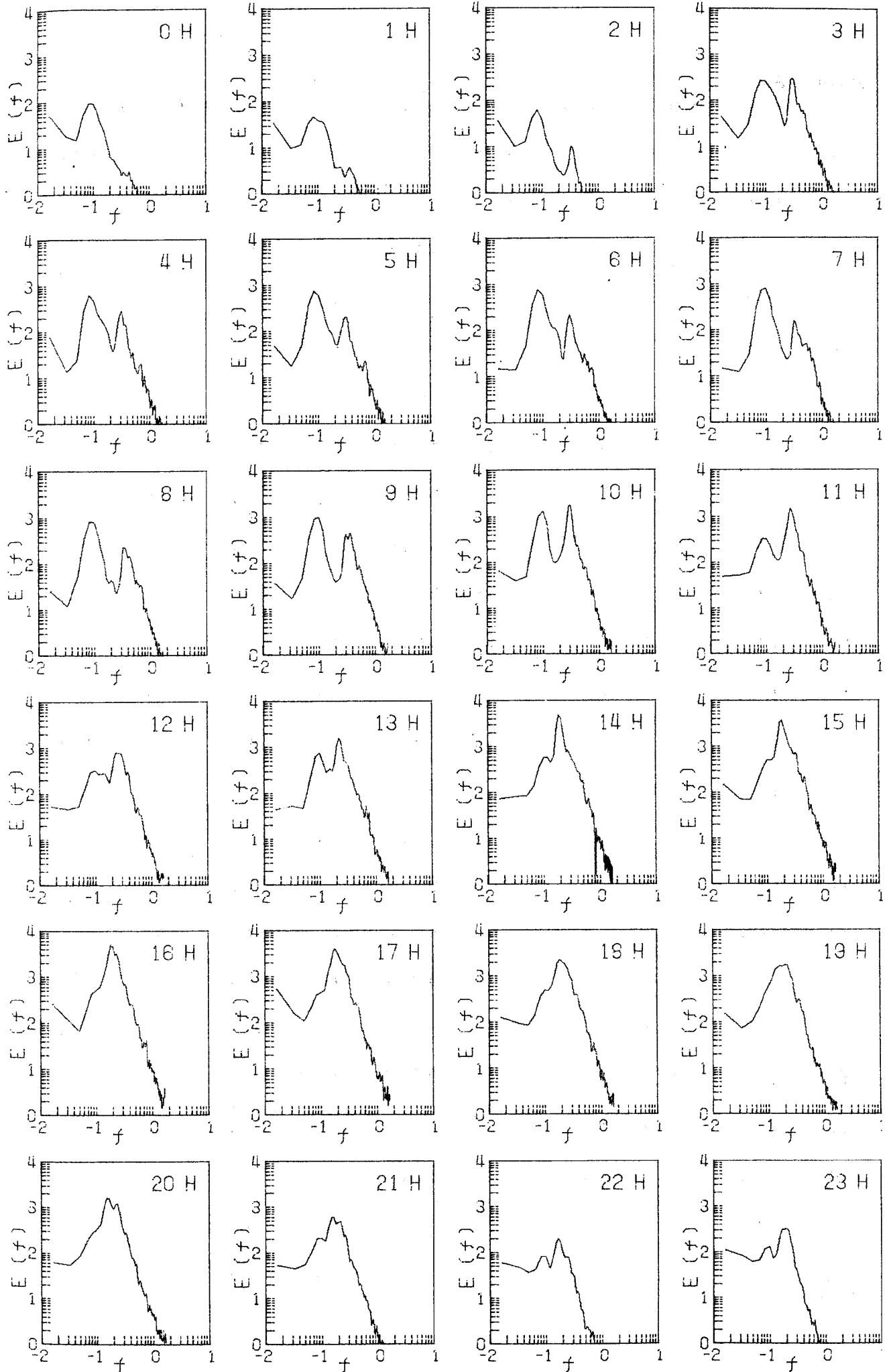

1978 12 03

HOUR	WAVE NUMBER	T (AVE)	H (AVE)	T (1/3)	H (1/3)	T (1/10)	H (1/10)	T (MAX)	H (MAX)
0	119	5.0	22.1	5.3	30.1	5.5	36.1	7.2	48.7
1	116	5.1	19.5	6.4	28.3	7.2	34.6	5.4	43.6
2	105	5.7	20.5	6.6	33.3	6.4	46.9	6.6	71.8
3	103	5.8	21.3	6.9	34.1	7.0	41.7	6.0	51.6
4	114	5.2	37.6	6.7	60.3	6.9	76.9	7.8	92.7
5	136	4.4	34.3	6.2	56.3	6.6	69.9	6.0	85.3
6	119	5.0	37.6	7.0	61.4	6.9	75.5	6.9	94.5
7	135	4.4	32.8	6.7	57.1	6.6	71.6	6.0	81.3
8	139	4.3	28.2	6.3	49.4	6.9	63.6	7.8	80.6
9	133	4.5	29.4	6.6	51.8	6.9	68.5	7.8	89.4
10	112	5.3	35.3	6.6	56.1	6.4	70.8	6.6	91.2
11	121	4.9	28.3	6.4	45.7	6.4	55.5	6.3	58.2
12	131	4.5	20.4	6.7	35.7	7.5	44.7	7.8	48.7
13	136	4.4	19.7	6.3	31.8	6.4	38.1	5.7	42.8
14	144	4.1	19.7	6.0	32.2	6.5	39.3	6.3	46.5
15	126	4.7	28.1	6.9	46.0	7.0	57.2	6.9	65.9
16	155	3.9	25.9	6.0	43.6	6.8	54.0	6.3	75.8
17	166	3.6	21.9	5.5	36.4	6.4	48.9	7.2	61.5
18	156	3.8	21.0	6.2	36.8	6.8	47.0	6.6	58.2
19	161	3.7	21.9	5.8	37.7	6.2	48.1	6.6	64.1
20	175	3.4	18.2	5.6	30.2	6.1	38.8	8.1	53.5
21	146	4.0	14.1	6.2	25.2	6.3	34.4	6.3	43.2
22	115	5.1	5.5	6.7	9.7	7.3	12.9	5.1	16.1
23	123	4.7	4.6	7.8	8.2	8.6	9.7	8.7	10.6

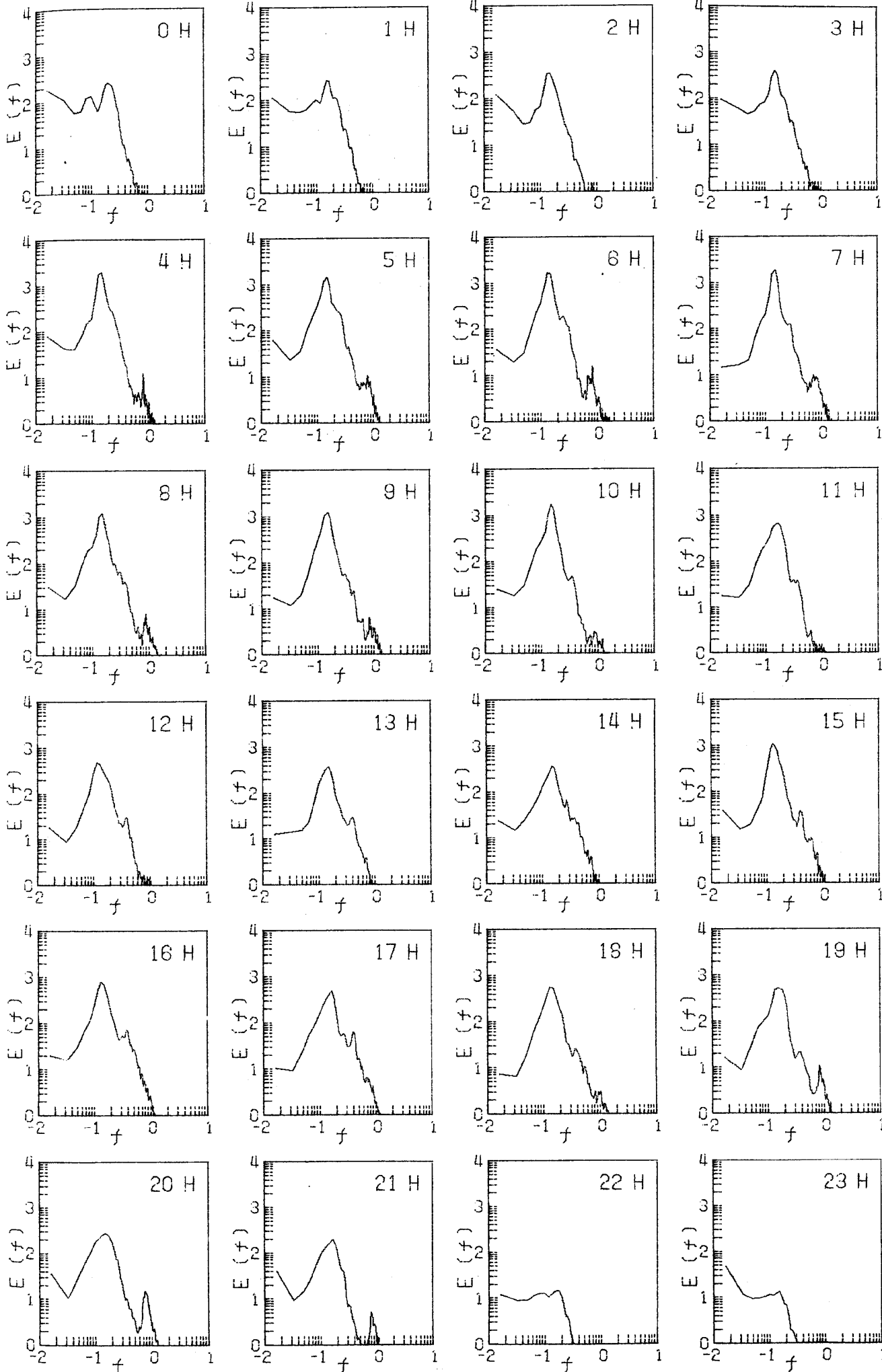

1978 12 04

HOUR	WAVE NUMBER	T (AVE)	H (AVE)	T (1/3)	H (1/3)	T (1/10)	H (1/10)	T (MAX)	H (MAX)
0	161	3.7	4.4	7.1	7.4	9.1	9.1	11.4	12.5
1	174	3.4	3.8	6.3	6.0	8.6	7.5	8.4	8.8
2	100	6.0	4.2	10.5	6.9	13.0	8.3	15.9	11.7
3	120	4.9	5.5	8.0	7.9	8.2	9.1	5.7	10.6
4	119	4.9	9.8	8.4	17.6	9.1	22.0	9.6	24.5
5	160	3.7	11.6	7.0	22.0	8.0	31.2	8.1	41.7
6	161	3.7	16.4	6.5	29.4	8.6	41.2	9.6	51.6
7	171	3.5	14.5	6.4	26.7	8.4	38.6	10.8	52.7
8	158	3.7	18.6	6.4	33.1	7.9	47.3	6.9	72.5
9	128	4.6	18.0	7.9	32.9	8.9	47.2	7.5	69.9
10	109	5.4	21.4	8.6	39.1	9.2	50.4	8.4	71.4
11	98	6.0	23.2	8.6	39.8	8.1	47.9	8.4	57.5
12	116	5.1	19.6	8.3	33.4	8.7	40.4	9.0	45.8
13	169	3.5	19.8	6.1	32.8	8.4	45.7	9.3	69.9
14	182	3.2	47.4	3.8	70.5	4.2	86.5	8.1	103.6
15	171	3.5	53.9	4.4	81.2	4.1	99.0	3.9	123.4
16	160	3.7	73.9	4.3	111.1	4.0	137.2	3.6	172.5
17	175	3.4	60.7	4.3	90.4	4.5	105.3	3.6	128.5
18	186	3.2	63.5	4.1	102.8	4.0	130.2	3.6	167.0
19	177	3.4	53.6	4.1	81.9	4.3	101.1	5.4	123.8
20	174	3.4	51.2	4.4	79.7	4.2	99.0	4.5	116.1
21	157	3.8	46.0	4.6	69.8	4.2	84.0	5.1	111.3
22	159	3.8	46.0	5.2	75.8	5.4	98.9	5.4	141.0
23	134	4.5	35.2	5.5	54.3	5.7	69.6	6.0	85.7

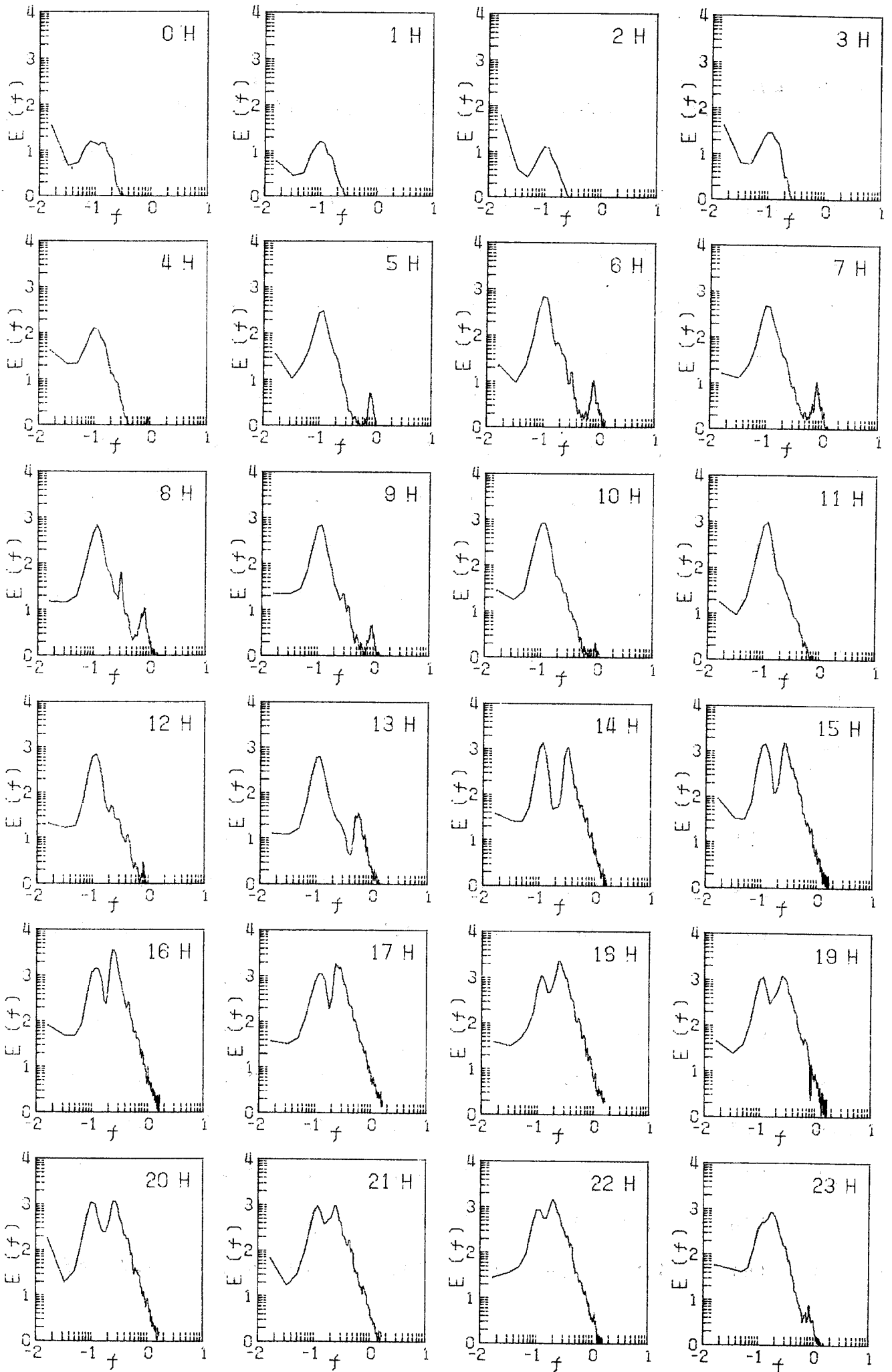

1978 12 05

HOUR	WAVE NUMBER	T (AVE)	H (AVE)	T (1/3)	H (1/3)	T (1/10)	H (1/10)	T (MAX)	H (MAX)
0	96	6.2	42.4	6.9	68.2	6.2	94.2	6.3	132.6
1	101	5.9	39.1	6.6	67.5	7.0	92.8	6.3	157.5
2	108	5.5	32.8	6.9	56.7	7.0	74.8	6.9	88.6
3	90	6.6	45.4	7.9	77.8	8.1	97.7	7.5	108.8
4	97	6.2	39.1	7.9	66.3	8.4	86.2	7.5	116.1
5	96	6.1	44.4	8.1	70.0	8.1	84.3	7.8	98.9
6	103	5.8	45.1	7.7	72.2	7.6	92.3	8.1	105.5
7	118	5.0	39.6	7.9	74.0	8.5	103.1	7.8	130.0
8	111	5.4	43.6	7.5	73.3	7.7	90.6	7.5	114.3
9	121	4.9	34.3	7.6	63.2	7.7	79.3	8.1	96.3
10									
11									
12									
13									
14	111	5.3	37.2	7.7	66.8	8.3	87.7	9.9	98.9
15	114	5.1	33.5	7.4	56.3	7.4	67.3	7.2	87.9
16	125	4.7	34.6	7.6	59.5	7.6	72.5	8.1	79.5
17	119	5.0	39.9	8.0	67.2	8.2	81.8	7.8	97.0
18	160	3.7	28.7	6.9	52.0	7.9	71.8	7.2	103.4
19	140	4.2	30.8	7.5	53.3	7.7	65.9	8.4	80.6
20	117	5.1	35.6	8.0	59.6	7.8	74.2	6.9	82.8
21	171	3.5	25.6	6.3	45.0	7.6	63.8	8.1	91.2
22	150	3.9	20.7	7.1	38.6	8.1	52.4	8.4	63.7
23	151	3.9	16.4	6.6	30.2	8.0	40.3	8.7	47.2

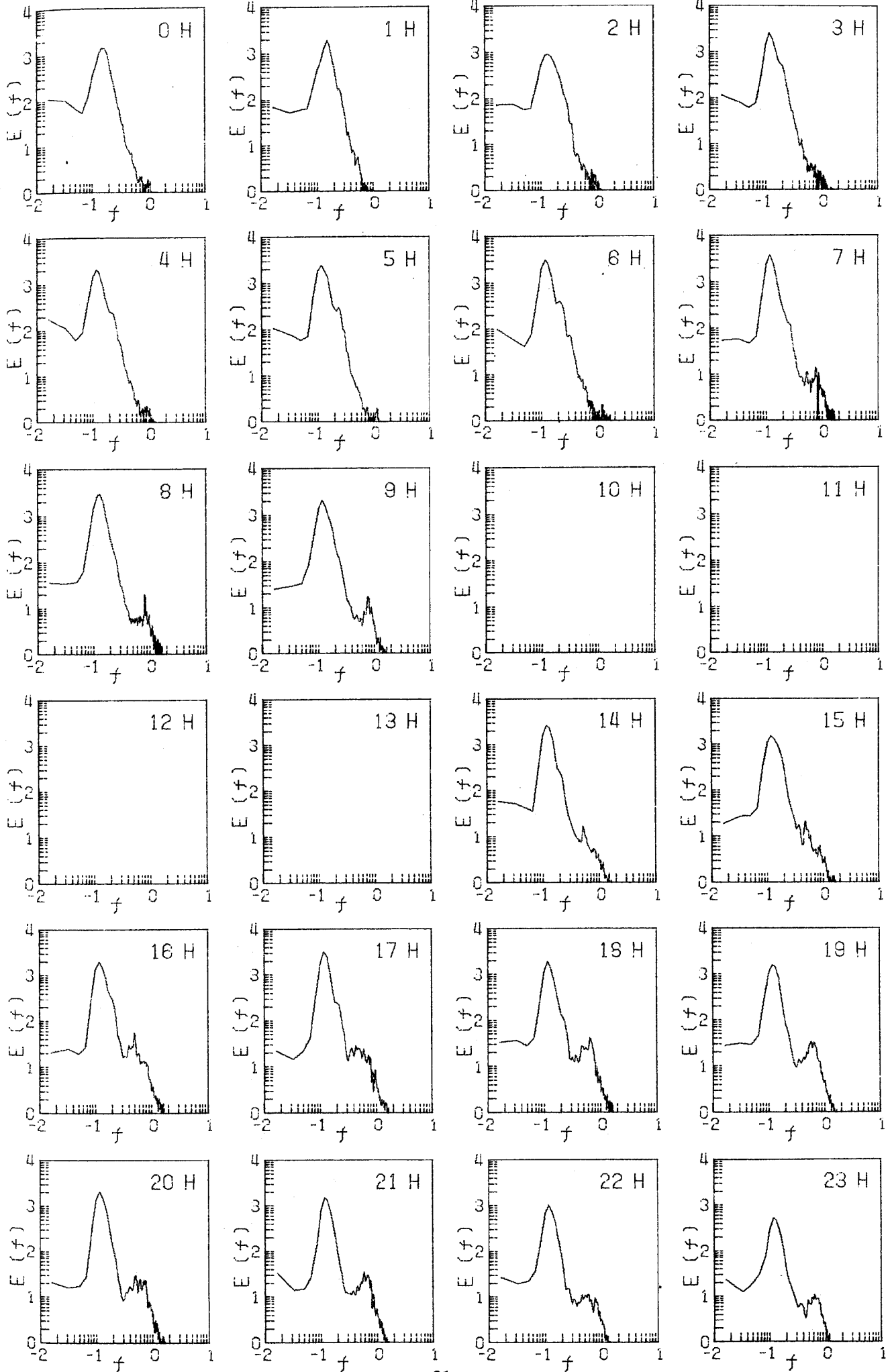

1978 12 06

HOUR	WAVE NUMBER	T (AVE)	H (AVE)	T (1/3)	H (1/3)	T (1/10)	H (1/10)	T (MAX)	H (MAX)
0	129	4.6	14.7	7.6	25.5	7.9	31.0	9.0	37.4
1	128	4.6	10.9	7.4	19.7	7.1	28.0	7.2	34.4
2	146	4.1	11.1	7.0	17.3	7.8	21.2	6.6	26.4
3	133	4.4	12.8	7.0	20.4	7.4	26.4	7.5	37.4
4	159	3.7	8.8	5.9	13.6	7.3	16.9	6.9	21.2
5	127	4.6	13.0	6.3	21.0	7.4	25.8	6.9	30.0
6	154	3.9	13.7	6.4	24.2	7.9	31.9	8.7	41.4
7	140	4.2	17.5	6.9	29.0	8.2	36.5	8.7	45.0
8	155	3.9	18.0	6.8	31.1	8.3	41.9	6.9	57.5
9	153	3.9	19.8	6.5	34.0	8.0	44.2	8.1	63.4
10	154	3.8	19.7	6.5	35.5	8.1	50.1	8.1	63.7
11	149	4.0	20.8	6.7	37.2	7.9	49.5	7.5	60.4
12	158	3.8	18.4	6.3	32.1	7.8	41.8	4.2	50.2
13	138	4.3	15.4	7.4	26.5	8.3	32.1	8.1	38.5
14	121	4.9	13.3	7.5	22.7	7.7	29.8	8.1	40.3
15	108	5.5	12.2	8.0	21.6	8.2	28.6	7.5	33.0
16	126	4.7	11.5	7.7	21.5	7.7	28.0	7.5	31.9
17	133	4.5	11.9	6.8	20.0	7.3	25.1	6.9	34.8
18	148	4.0	13.6	6.4	22.6	6.7	28.8	8.1	35.2
19	130	4.5	17.9	7.1	31.3	7.1	37.8	7.8	46.1
20	137	4.3	18.1	7.1	31.9	7.8	39.8	8.7	50.5
21	125	4.8	19.7	7.2	33.0	7.0	38.7	9.0	45.8
22	131	4.6	15.7	7.2	28.4	7.7	37.3	6.6	46.1
23	146	4.1	11.7	6.5	20.5	8.7	28.7	7.2	40.3

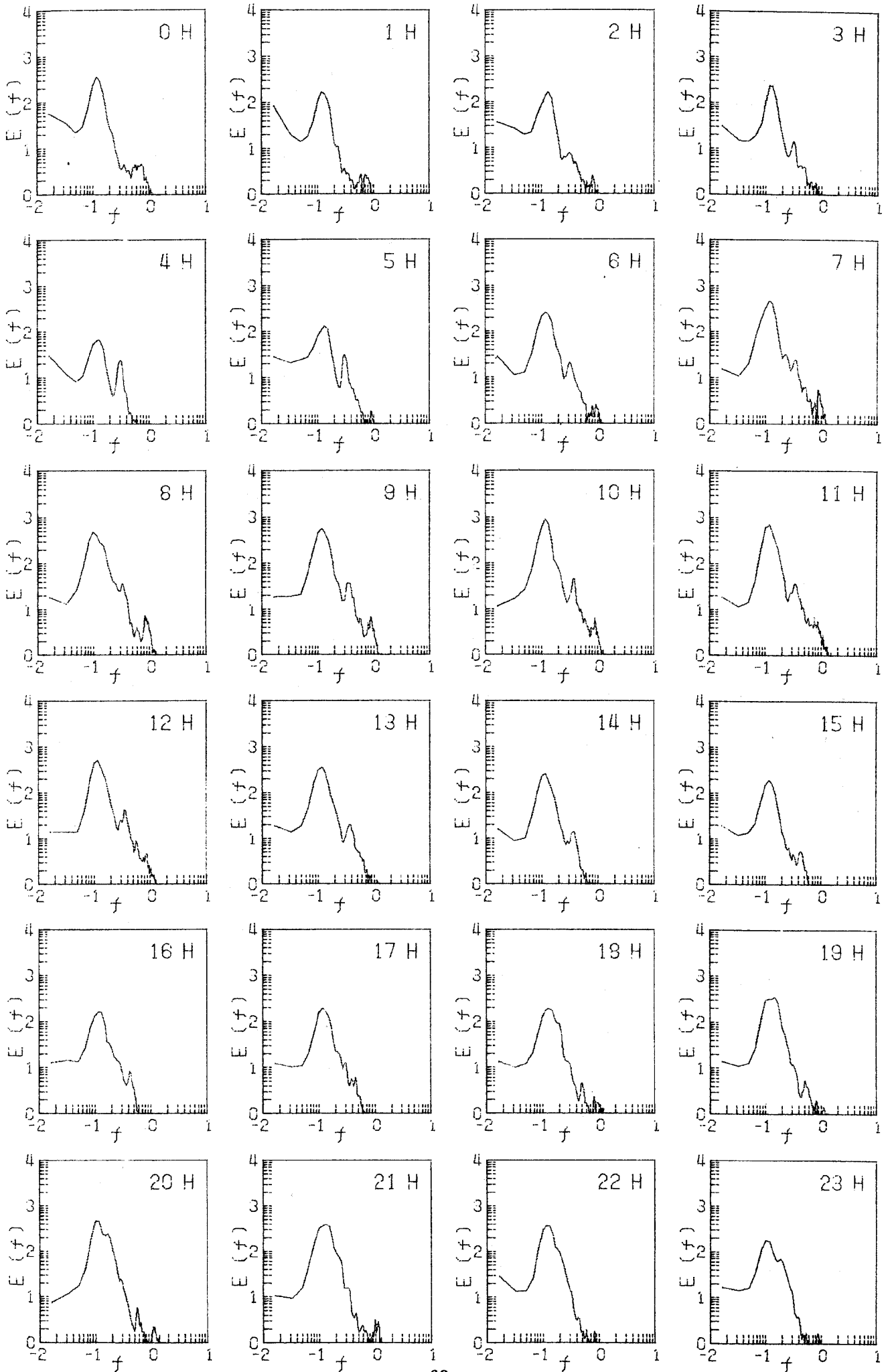

1978 12 07

HOUR	WAVE NUMBER	T (AVE)	H (AVE)	T (1/3)	H (1/3)	T (1/10)	H (1/10)	T (MAX)	H (MAX)
0	133	4.5	10.5	7.5	18.8	8.4	25.1	9.9	34.4
1	124	4.7	11.4	8.3	18.6	8.3	21.9	9.6	26.7
2	108	5.4	7.3	8.3	14.0	8.8	19.3	9.3	28.9
3	146	4.1	4.9	6.7	8.8	8.4	12.5	9.3	24.2
4	118	5.0	7.2	7.8	13.6	9.3	18.5	9.3	25.6
5	124	4.8	5.9	7.9	11.4	8.9	15.7	9.3	18.3
6	152	3.9	10.6	7.1	18.0	8.4	23.2	8.1	27.8
7	130	4.5	11.2	7.9	22.0	8.5	31.1	8.4	42.8
8	144	4.1	16.0	7.2	28.5	9.1	38.3	9.3	43.2
9	134	4.4	17.4	8.1	32.4	8.8	40.6	7.2	48.7
10	140	4.3	19.1	7.3	33.1	8.4	44.5	8.4	65.9
11	119	5.0	22.8	8.2	39.9	8.9	49.5	9.6	67.4
12	116	5.1	21.0	8.1	36.6	9.1	46.2	8.7	52.0
13	98	6.0	25.7	9.0	44.1	9.6	57.0	8.1	74.7
14	98	6.0	20.9	8.8	34.1	9.4	45.0	9.3	61.2
15	131	4.5	15.6	7.6	27.3	9.2	39.8	9.6	52.7
16	127	4.6	11.5	7.7	21.1	8.4	29.7	11.7	36.6
17	175	3.4	13.6	5.4	23.0	7.0	31.4	10.2	46.1
18	140	4.2	18.6	6.9	33.0	8.1	43.2	7.5	60.8
19	125	4.7	18.8	7.2	32.2	7.8	43.5	7.8	59.3
20	129	4.6	17.3	7.5	28.7	8.7	37.7	7.2	45.0
21	128	4.6	19.2	8.1	35.1	8.8	45.3	8.4	54.9
22	133	4.5	18.8	7.8	33.3	8.9	44.2	8.7	56.4
23	122	4.8	19.1	8.1	32.0	8.4	39.7	8.7	44.3

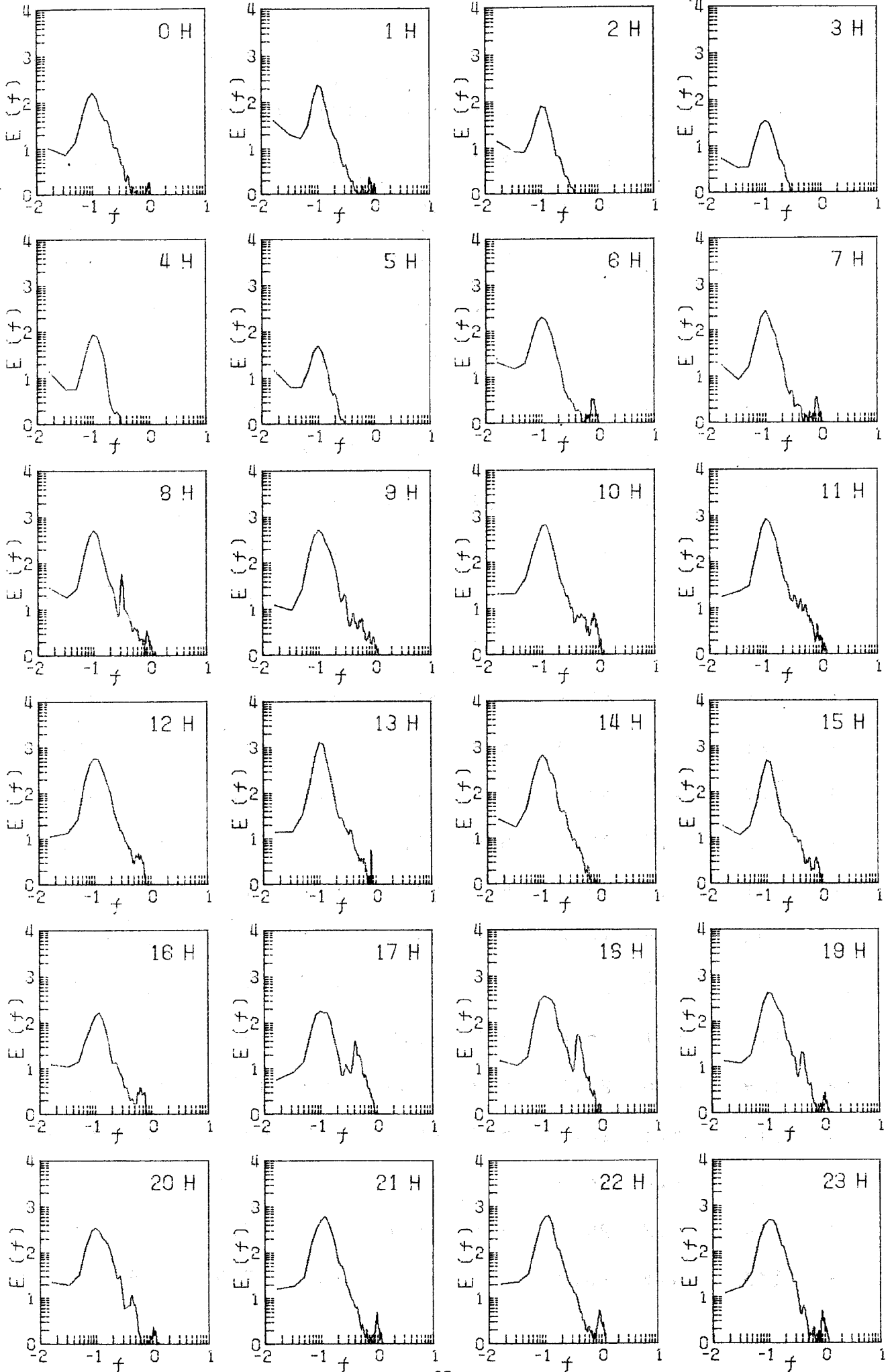

1978 12 08

HOUR	WAVE NUMBER	T (AVE)	H (AVE)	T (1/3)	H (1/3)	T (1/10)	H (1/10)	T (MAX)	H (MAX)
0	141	4.2	14.2	7.2	23.6	9.2	31.1	9.9	43.6
1	119	4.9	12.2	7.7	22.7	8.6	31.0	12.0	40.3
2	120	5.0	11.2	8.5	19.4	9.1	25.0	9.3	33.3
3	147	4.1	11.5	6.9	17.7	9.0	21.4	10.2	31.9
4	137	4.4	11.8	6.3	18.3	6.8	21.5	3.9	27.1
5	132	4.5	14.6	6.6	21.6	7.5	24.8	11.4	27.5
6	154	3.9	14.9	5.9	22.0	6.3	27.3	4.8	35.5
7	136	4.4	15.1	5.7	24.5	6.9	32.8	8.4	42.8
8	138	4.3	22.3	5.2	35.5	4.8	45.3	4.2	54.9
9	150	4.0	28.2	5.1	42.4	4.9	53.4	6.6	64.8
10	137	4.3	32.8	4.7	48.5	4.8	59.0	3.9	77.3
11	128	4.7	41.1	5.1	61.5	5.2	73.6	4.8	88.3
12	125	4.8	37.0	5.7	58.8	5.3	68.3	4.5	79.1
13	127	4.7	43.3	5.4	64.2	5.9	77.3	5.1	92.3
14	132	4.5	35.5	5.5	55.2	5.6	70.2	5.1	90.8
15	141	4.2	35.4	5.3	57.7	5.2	74.7	4.8	111.7
16	120	5.0	34.6	5.5	56.9	5.7	76.9	5.7	109.9
17	115	5.2	27.7	5.9	45.9	6.0	64.4	5.7	87.9
18	115	5.1	26.6	6.1	41.9	5.9	53.5	5.7	80.2
19	129	4.6	23.0	5.9	35.3	5.9	44.8	6.0	59.3
20	115	5.1	28.2	5.9	46.8	5.9	63.0	5.4	87.9
21	118	5.0	26.6	6.0	43.5	5.9	53.5	5.7	62.3
22	114	5.2	29.0	6.3	46.1	5.7	57.1	6.0	73.2
23	133	4.5	26.8	6.2	45.1	6.0	57.9	4.8	66.3

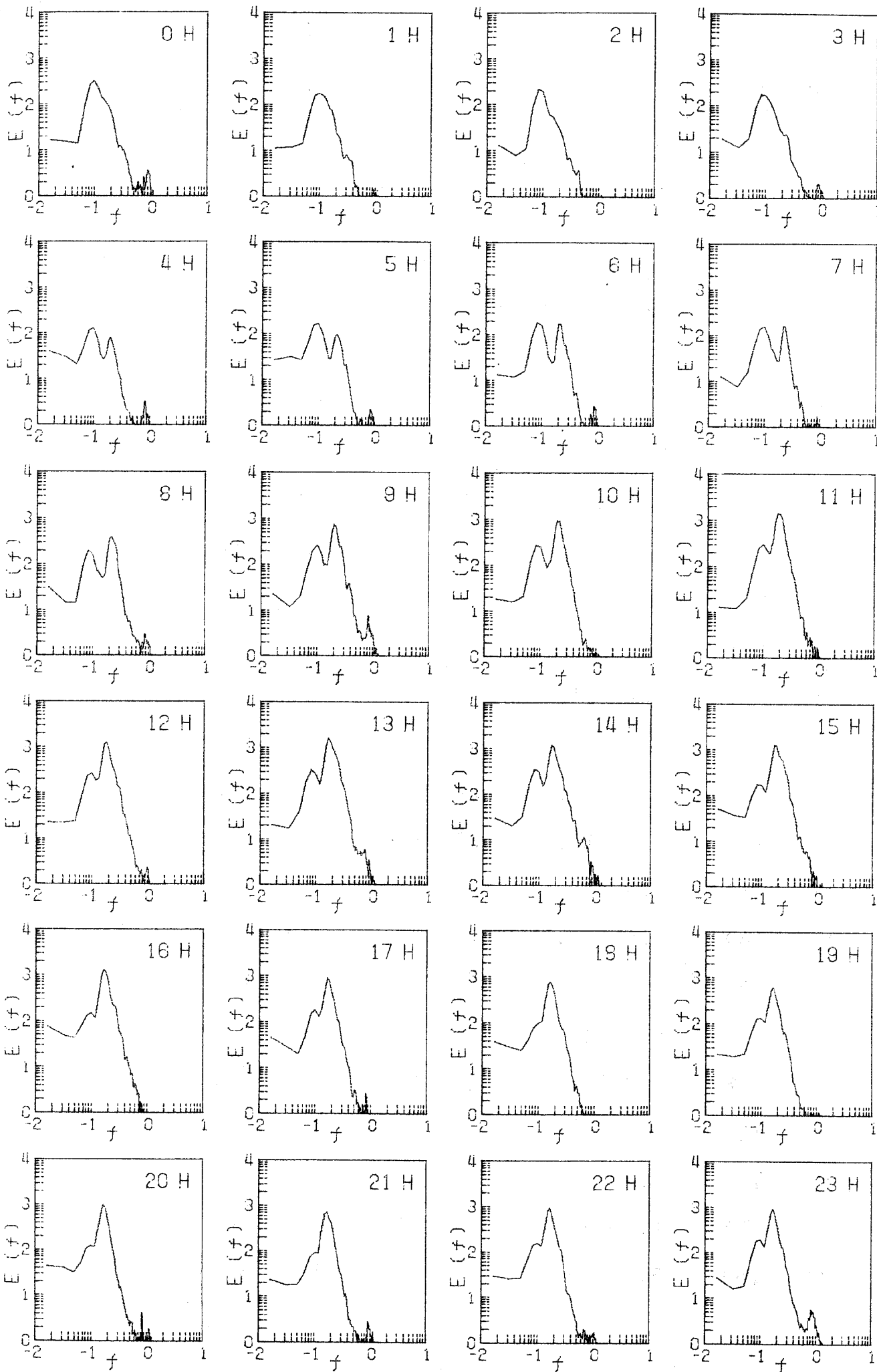

1978 12 09

HOUR	WAVE NUMBER	T (AVE)	H (AVE)	T (1/3)	H (1/3)	T (1/10)	H (1/10)	T (MAX)	H (MAX)
0	141	4.2	21.5	6.2	35.8	6.8	45.0	7.8	57.5
1	149	4.0	18.6	5.8	32.5	6.4	42.7	6.9	56.4
2	141	4.2	17.8	6.4	30.4	7.0	39.6	6.0	48.0
3	117	5.0	13.7	6.5	22.8	6.4	27.9	6.3	37.0
4	126	4.7	14.5	7.0	24.0	7.4	30.1	5.1	40.3
5	120	5.0	13.0	8.1	21.0	9.4	26.5	7.5	37.0
6	125	4.8	11.1	7.3	16.8	8.6	19.8	9.3	28.2
7	135	4.4	10.1	7.1	17.5	8.9	23.4	9.3	30.0
8	135	4.4	9.7	7.0	18.7	8.0	26.4	8.7	41.4
9	147	4.0	12.7	6.7	21.3	7.7	27.2	6.0	31.5
10	123	4.8	16.6	7.2	26.3	8.3	33.1	10.8	46.9
11	134	4.4	17.5	6.4	28.4	7.5	34.9	9.0	44.3
12	110	5.4	18.2	7.7	29.7	8.9	35.0	8.1	48.3
13	133	4.5	16.3	7.1	27.2	8.0	33.6	10.5	42.5
14	123	4.8	16.7	7.7	28.2	9.4	34.8	9.3	44.3
15	138	4.3	17.5	6.7	27.9	8.5	34.9	6.0	40.6
16	149	4.0	11.7	6.2	19.0	7.7	24.2	8.7	31.5
17	178	3.4	9.8	5.3	15.6	7.6	19.8	9.0	27.1
18	142	4.2	11.2	6.8	16.3	8.6	18.6	11.4	21.2
19	146	4.0	12.4	5.9	19.2	7.7	23.4	9.9	27.5
20	111	5.3	12.1	8.4	19.9	9.2	23.9	9.9	28.6
21	127	4.7	12.4	7.2	18.0	8.4	21.5	9.6	28.6
22	135	4.4	12.2	6.4	20.2	7.3	26.5	7.8	30.4
23	153	3.9	18.0	4.8	28.4	5.1	36.4	6.3	45.8

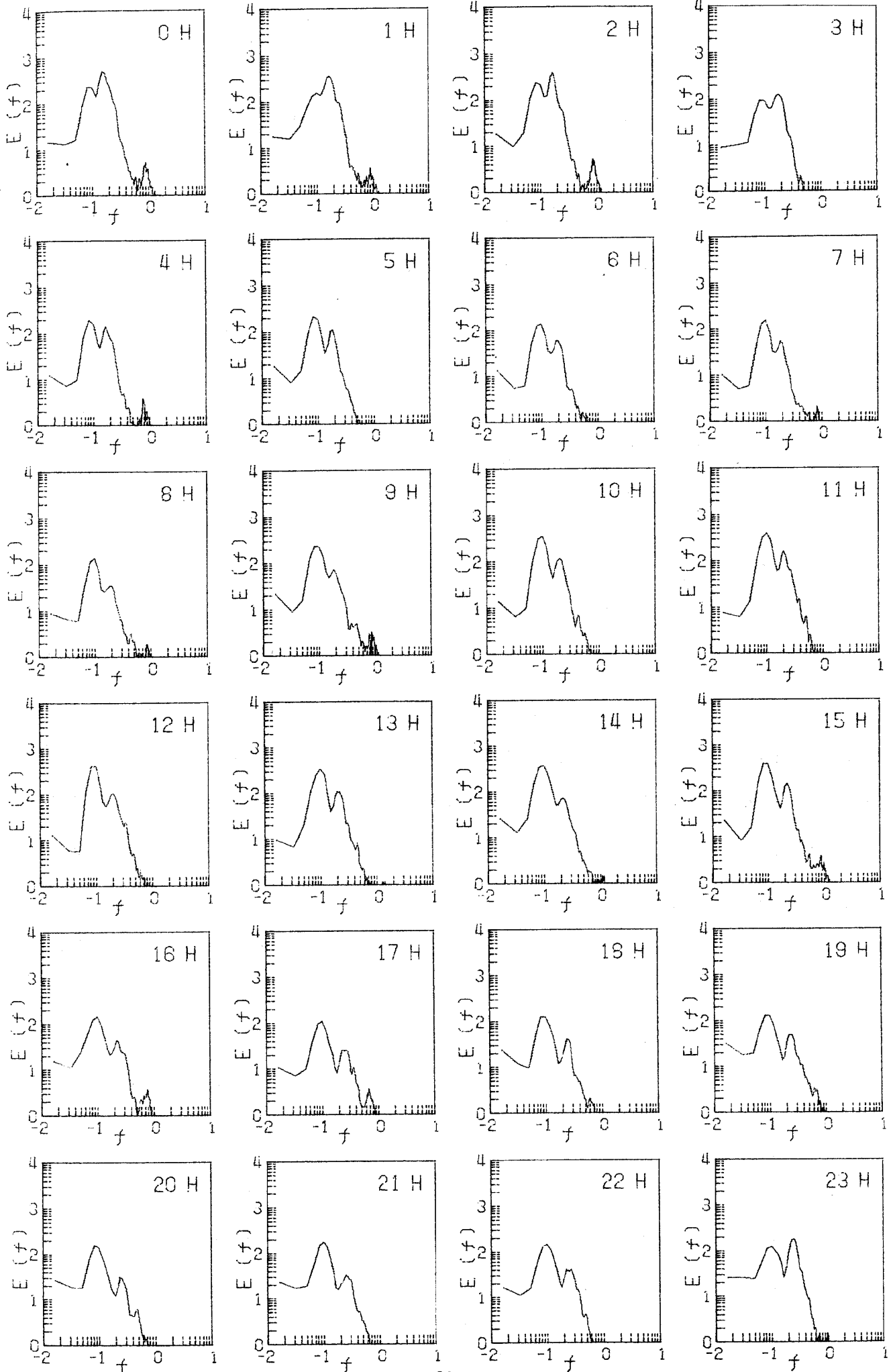

1978 12 10

HOUR	WAVE NUMBER	T (AVE)	H (AVE)	T (1/3)	H (1/3)	T (1/10)	H (1/10)	T (MAX)	H (MAX)
0	149	4.0	28.2	5.2	43.9	5.7	55.6	8.4	73.2
1	168	3.5	34.4	4.2	51.6	4.0	61.6	3.6	71.4
2	182	3.3	29.9	4.2	44.9	4.2	54.2	3.3	69.9
3	190	3.1	32.4	3.9	50.2	3.9	63.9	3.6	92.7
4	194	3.1	33.1	3.9	51.1	3.7	63.9	6.3	80.2
5	185	3.2	37.7	3.7	59.7	4.0	73.2	4.2	94.1
6	188	3.2	37.7	4.0	61.6	4.2	77.0	2.7	102.9
7	178	3.3	36.2	3.8	58.4	4.2	76.9	3.6	117.2
8	190	3.1	32.8	3.8	51.7	3.8	65.7	3.3	101.8
9	174	3.4	34.8	4.3	56.2	4.4	73.2	3.6	90.8
10	170	3.5	45.3	4.8	74.9	5.2	95.5	6.3	129.3
11	160	3.7	57.5	4.6	90.0	5.0	111.3	5.4	163.0
12	145	4.1	67.9	5.1	104.6	5.1	124.8	5.4	139.5
13	144	4.1	77.9	4.9	114.9	4.7	142.7	5.1	187.5
14	137	4.3	84.6	5.3	129.9	5.5	158.1	4.8	192.6
15	128	4.6	69.4	5.9	112.5	5.7	134.2	6.0	158.9
16	126	4.7	64.1	6.0	102.5	6.4	130.2	7.5	149.0
17	133	4.4	55.1	5.7	92.2	6.3	116.3	5.7	148.3
18	139	4.3	41.5	5.5	66.4	5.4	83.0	5.7	104.7
19	133	4.5	39.0	5.7	62.5	5.9	88.3	5.4	134.8
20	127	4.6	41.1	5.8	63.1	6.0	80.1	6.3	95.2
21	119	5.0	54.5	6.1	86.7	6.2	114.8	7.8	139.2
22	122	4.8	50.8	6.0	82.2	6.4	102.4	6.3	153.4
23	108	5.5	53.9	6.6	85.0	6.7	108.8	8.4	126.7

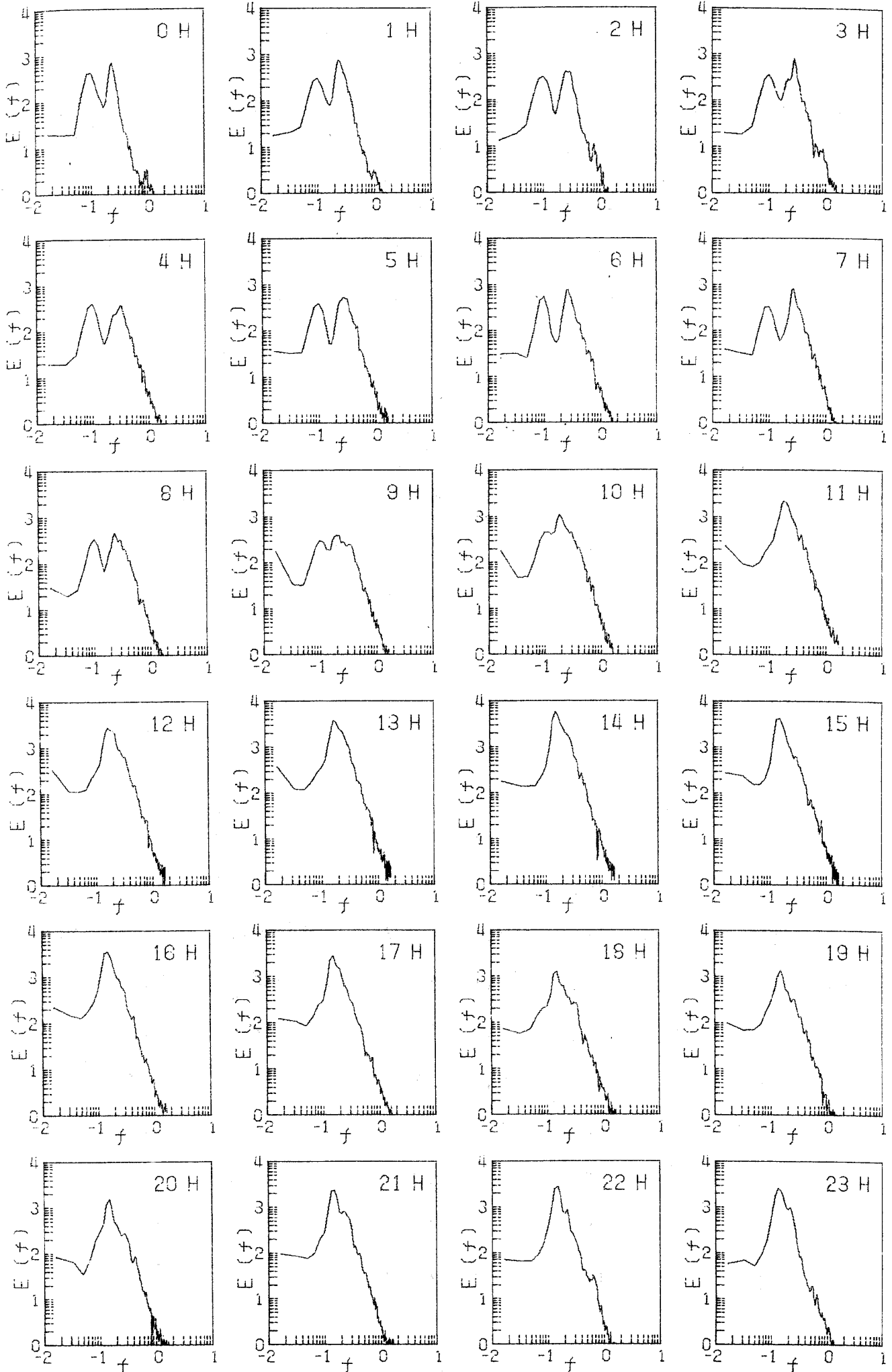

1978 12 11

HOUR	WAVE NUMBER	T (AVE)	H (AVE)	T (1/3)	H (1/3)	T (1/10)	H (1/10)	T (MAX)	H (MAX)
0	107	5.6	49.3	6.9	78.6	7.1	98.0	8.1	107.7
1	116	5.1	45.6	7.2	74.5	7.2	87.5	7.2	101.8
2	147	4.0	35.9	6.7	64.3	7.5	84.3	8.1	103.6
3	105	5.6	52.5	8.1	88.6	8.4	110.8	9.0	119.4
4	134	4.4	31.9	7.2	55.5	8.5	72.0	8.4	104.0
5	126	4.7	28.7	8.3	52.5	8.7	68.4	8.7	94.8
6	135	4.4	31.2	7.2	54.2	8.5	76.8	8.1	124.9
7	131	4.5	31.8	8.2	60.0	8.8	77.3	9.3	110.6
8	108	5.5	30.5	8.3	56.3	8.6	71.4	8.4	102.5
9	121	4.9	24.9	7.7	44.5	8.4	59.4	7.5	82.8
10									
11									
12									
13									
14	143	4.2	26.3	7.3	45.9	8.1	56.7	7.5	71.8
15	137	4.3	24.7	7.3	42.4	8.7	56.5	8.1	69.2
16	135	4.4	23.2	7.4	41.7	8.3	54.2	7.5	75.4
17	101	5.9	20.7	8.6	35.1	8.5	45.3	9.3	55.7
18	100	5.9	18.9	8.6	30.5	9.1	41.2	7.5	53.8
19	105	5.7	18.0	8.1	31.0	8.1	37.1	9.3	42.8
20	120	4.9	10.7	7.6	18.5	8.0	23.6	8.4	44.7
21	108	5.5	9.9	8.2	17.9	7.6	22.2	8.4	28.2
22	102	5.8	9.8	8.1	17.4	8.5	22.0	8.4	28.9
23	100	5.9	13.0	8.6	22.7	8.5	29.7	9.3	41.0

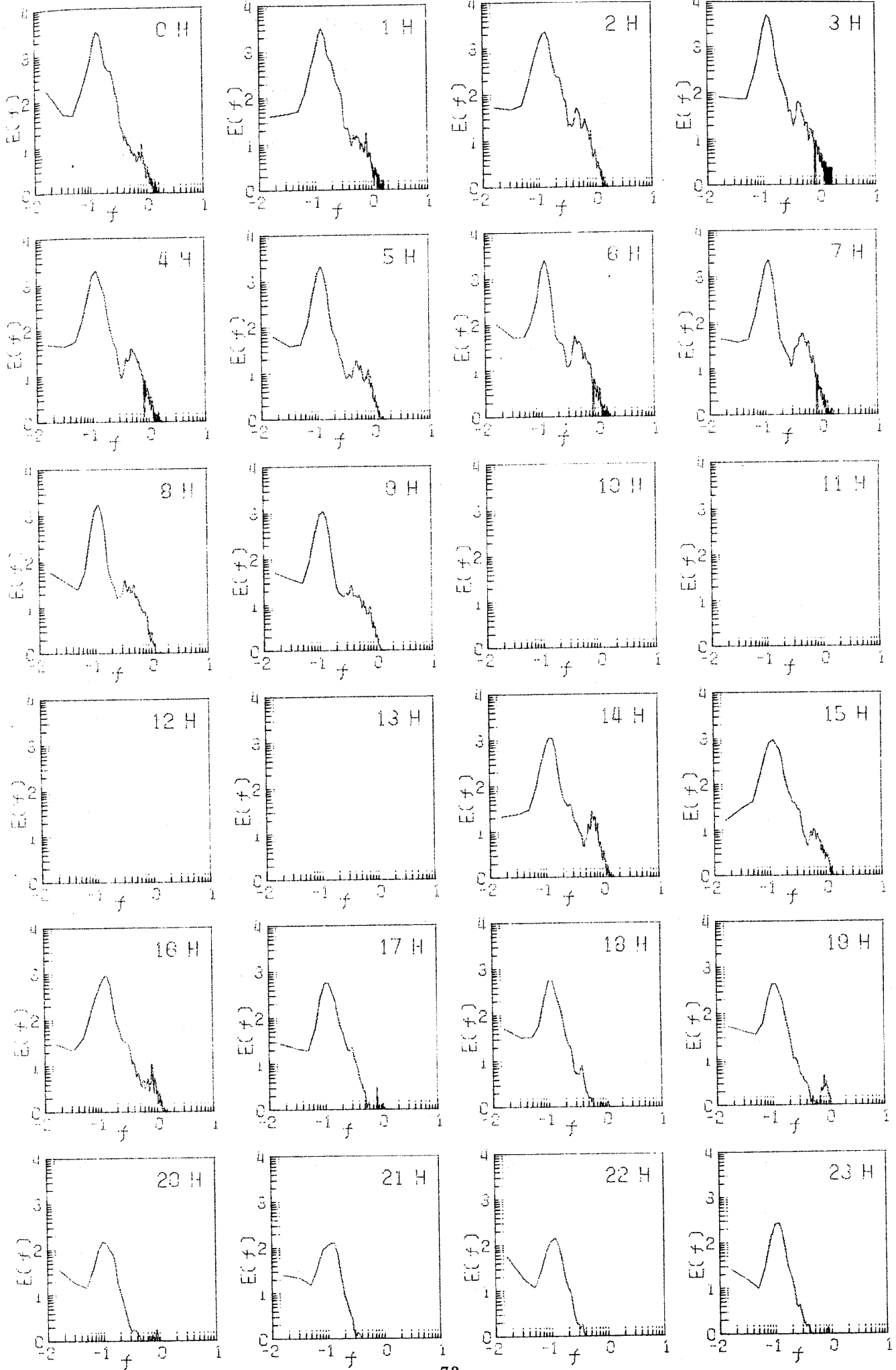

1978 12 12

HOUR	WAVE NUMBER	T (AVE)	H (AVE)	T (1/3)	H (1/3)	T (1/10)	H (1/10)	T (MAX)	H (MAX)
0	137	4.3	13.7	7.6	23.7	8.3	30.6	8.4	46.5
1	108	5.4	13.0	7.6	23.0	8.8	30.7	8.7	39.9
2	137	4.3	18.1	7.6	32.5	8.4	40.5	9.0	45.4
3	138	4.3	18.8	7.9	34.7	8.3	45.8	8.4	57.5
4	119	4.9	24.5	7.9	43.7	8.0	57.5	6.9	75.8
5	116	5.1	22.8	7.9	40.9	7.6	49.8	9.9	56.4
6	106	5.6	23.0	8.0	35.9	8.5	42.2	7.8	46.9
7	100	5.9	20.1	8.4	35.4	8.3	47.7	7.5	62.3
8	99	6.0	20.0	7.9	35.8	7.8	46.1	8.1	61.2
9	111	5.3	17.5	8.5	33.7	8.8	45.2	10.5	56.4
10	104	5.7	18.8	7.9	33.5	8.2	43.2	7.8	52.7
11	94	6.3	24.5	7.8	40.5	8.3	50.4	9.0	57.1
12	102	5.8	22.6	7.8	36.7	8.6	44.9	9.6	49.8
13	101	5.8	25.9	7.3	40.2	7.8	50.8	6.9	77.6
14	100	5.9	26.8	7.9	42.2	7.9	49.3	8.1	63.7
15	123	4.8	27.8	7.1	47.2	7.6	57.6	7.8	71.4
16	122	4.9	29.1	7.1	48.0	7.1	56.5	6.6	63.4
17	134	4.5	27.2	6.9	45.3	7.5	56.6	7.8	80.6
18	132	4.4	19.4	6.6	36.1	7.1	48.7	6.3	66.3
19	114	5.2	17.5	7.0	28.3	7.6	33.0	9.6	38.5
20	129	4.6	12.2	7.2	20.2	7.8	26.3	8.4	37.7
21	123	4.8	14.0	6.5	22.3	7.4	29.7	6.3	35.5
22	135	4.4	10.7	6.3	17.5	7.2	23.1	6.9	31.9
23	130	4.6	12.3	6.2	18.5	6.6	22.9	7.8	27.5

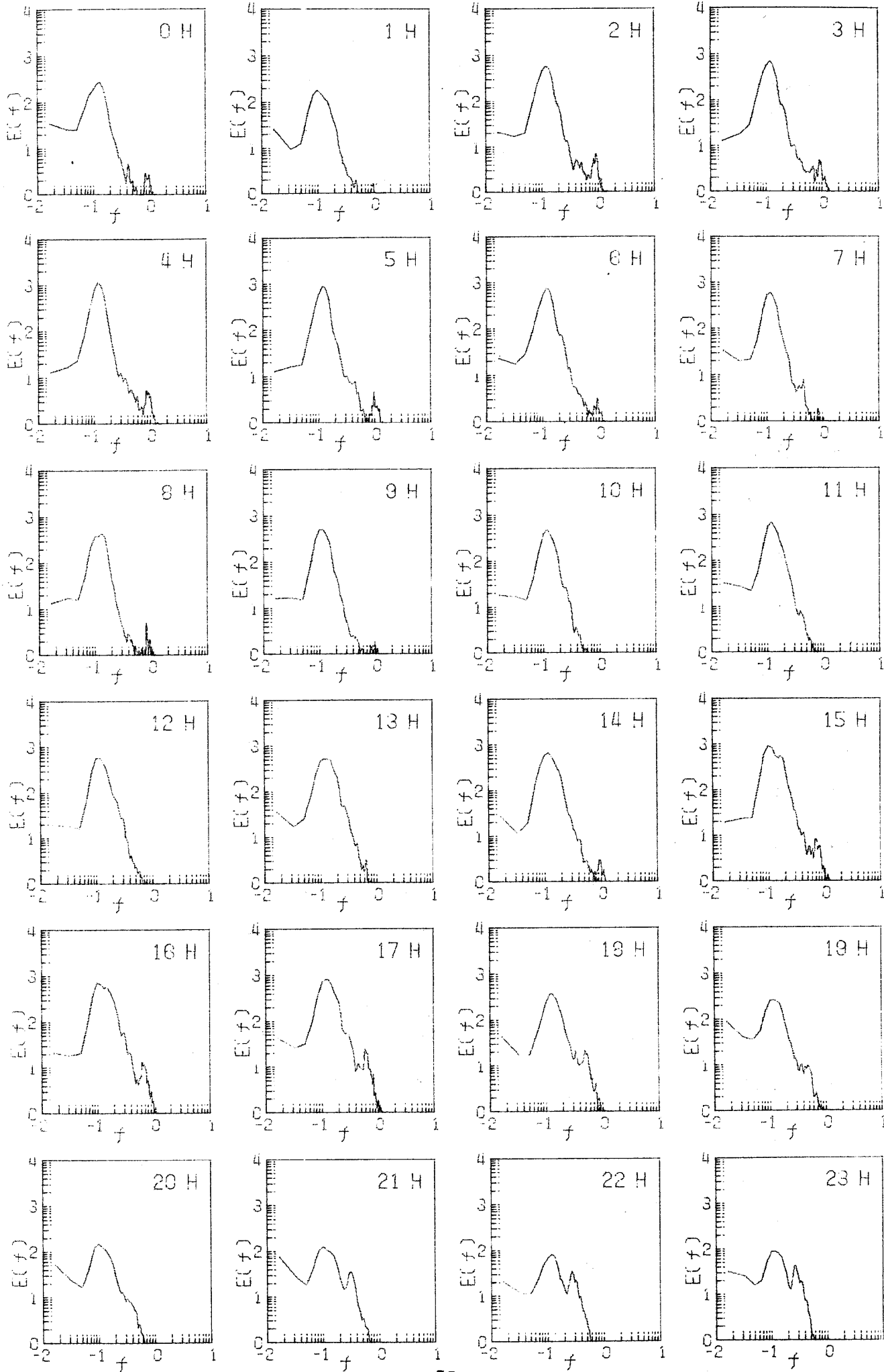

1978 12 13

HOUR	WAVE NUMBER	T (AVE)	H (AVE)	T (1/3)	H (1/3)	T (1/10)	H (1/10)	T (MAX)	H (MAX)
0	138	4.2	12.3	6.0	21.3	6.1	27.8	6.3	35.2
1	146	4.0	14.2	5.9	22.8	6.7	30.7	7.8	43.2
2	152	3.9	17.7	5.7	28.7	6.0	36.5	8.7	43.2
3	155	3.8	23.9	5.8	38.9	6.7	49.7	8.1	63.4
4	170	3.5	20.1	5.2	33.2	5.5	41.7	6.3	52.7
5	197	3.0	17.8	4.7	29.2	5.8	37.3	7.2	53.8
6	202	2.9	15.5	4.4	26.0	5.8	34.7	9.9	48.4
7	178	3.3	15.5	5.6	25.0	7.0	31.9	7.2	46.9
8	159	3.7	10.4	6.5	17.8	7.8	24.1	7.8	41.4
9	114	5.1	10.3	8.0	18.6	8.2	27.0	8.4	34.4
10	122	4.9	8.1	7.4	15.2	7.6	22.6	8.7	28.5
11									
12	114	5.2	15.0	7.8	23.9	7.8	29.5	8.4	33.7
13	123	4.8	15.6	7.5	25.0	7.7	31.3	7.5	35.5
14	131	4.5	15.2	7.2	26.8	8.0	35.6	8.1	47.2
15	163	3.6	14.5	6.3	25.4	7.9	34.6	8.1	42.8
16	189	3.1	14.5	5.5	25.2	7.2	36.6	7.2	54.2
17	175	3.4	19.6	5.6	30.9	7.6	39.4	8.1	57.5
18	179	3.3	20.0	4.7	32.0	6.3	40.0	7.8	55.3
19	156	3.8	15.9	5.2	23.8	5.0	30.2	7.2	38.8
20	144	4.1	11.0	6.3	17.6	7.0	23.6	7.5	34.1
21	118	5.0	7.2	7.3	12.0	7.8	15.9	7.8	19.0
22	115	5.1	6.6	8.0	10.7	8.5	12.8	8.1	17.5
23	135	4.4	5.0	7.5	8.7	8.1	11.4	6.9	13.9

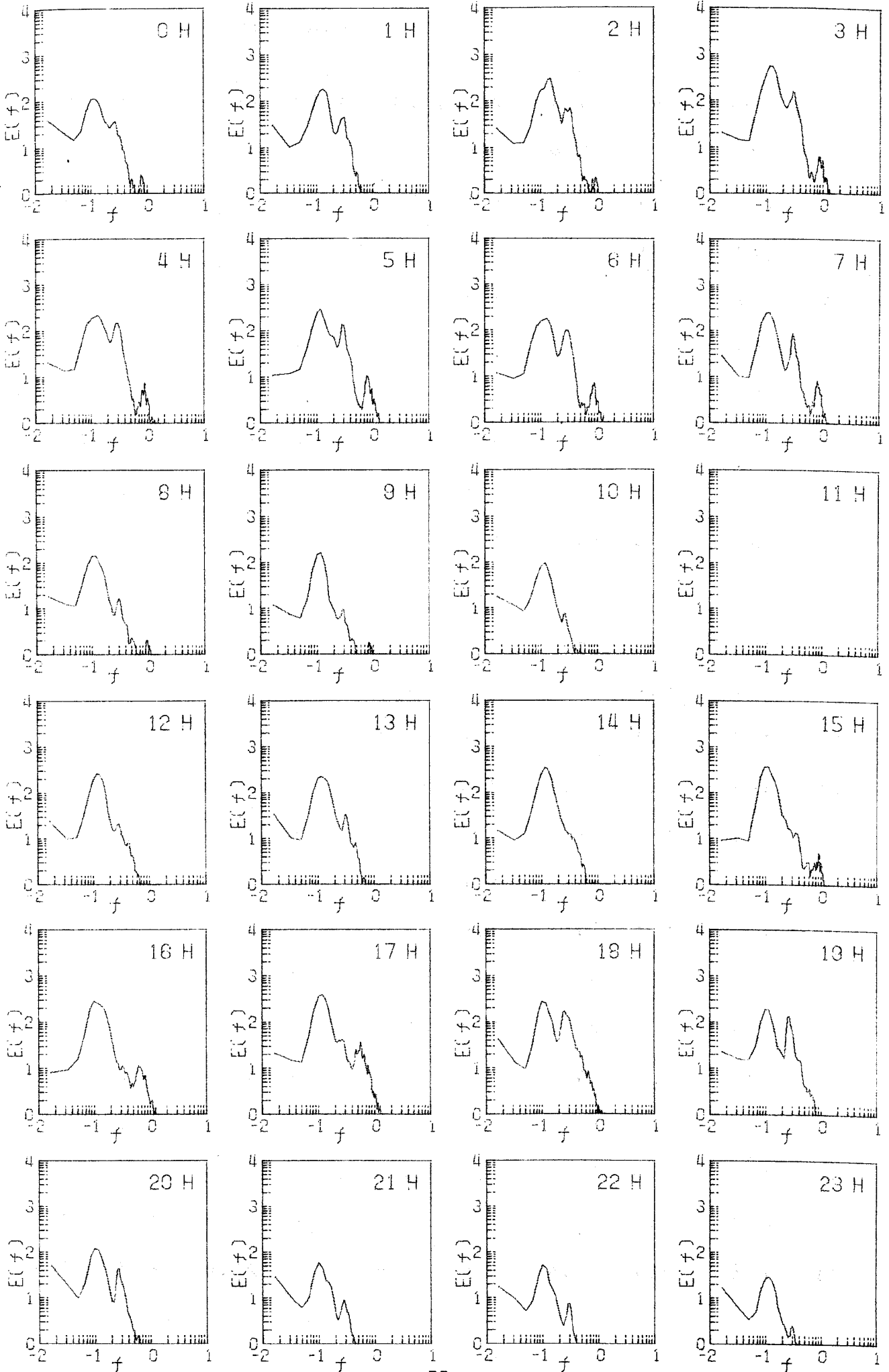

1978 12 14

HOUR	WAVE NUMBER	T (AVE)	H (AVE)	T (1/3)	H (1/3)	T (1/10)	H (1/10)	T (MAX)	H (MAX)
0	120	4.9	5.9	7.6	9.5	7.9	11.7	8.4	13.2
1	103	5.7	13.8	8.2	22.7	8.5	27.8	9.0	34.1
2	118	5.0	10.6	7.9	20.6	8.6	26.5	9.3	30.8
3	154	3.8	17.1	6.7	30.6	7.5	39.7	8.7	49.8
4	149	4.0	15.8	7.2	29.9	8.5	41.3	8.4	53.5
5	155	3.9	16.3	7.1	29.5	7.9	38.7	7.2	48.0
6	153	3.9	15.6	7.3	29.0	8.6	38.9	8.7	46.5
7	137	4.4	16.0	8.1	28.8	8.8	38.1	8.1	44.7
8	140	4.2	15.3	7.7	28.7	9.2	37.0	9.0	46.5
9	123	4.8	15.9	8.0	27.7	8.4	34.2	10.2	36.6
10	102	5.8	14.1	8.5	24.2	8.8	31.9	9.0	43.9
11	117	5.0	13.8	8.0	24.7	8.2	31.2	8.1	40.6
12	117	5.1	19.0	7.9	32.3	7.8	38.9	8.4	46.5
13	108	5.5	22.7	7.6	38.3	7.8	47.5	7.2	50.9
14	114	5.2	26.1	7.2	45.7	7.6	61.9	7.8	85.7
15	127	4.7	26.6	6.7	44.7	6.8	54.0	6.6	68.1
16	117	5.1	24.4	6.8	38.6	7.2	52.8	7.8	68.1
17	113	5.3	27.0	6.9	43.3	6.7	53.4	6.9	66.7
18	99	6.0	29.5	7.7	47.0	7.9	59.1	6.9	71.4
19	107	5.6	19.1	8.1	31.4	8.5	37.9	8.1	43.9
20	106	5.5	18.1	7.2	28.3	7.6	35.2	8.4	41.0
21	105	5.5	12.6	7.3	20.5	7.6	25.9	9.6	34.8
22	99	5.9	9.8	7.0	16.3	7.4	21.8	6.6	27.5
23	103	5.7	9.4	7.6	16.8	7.3	22.4	6.3	27.5

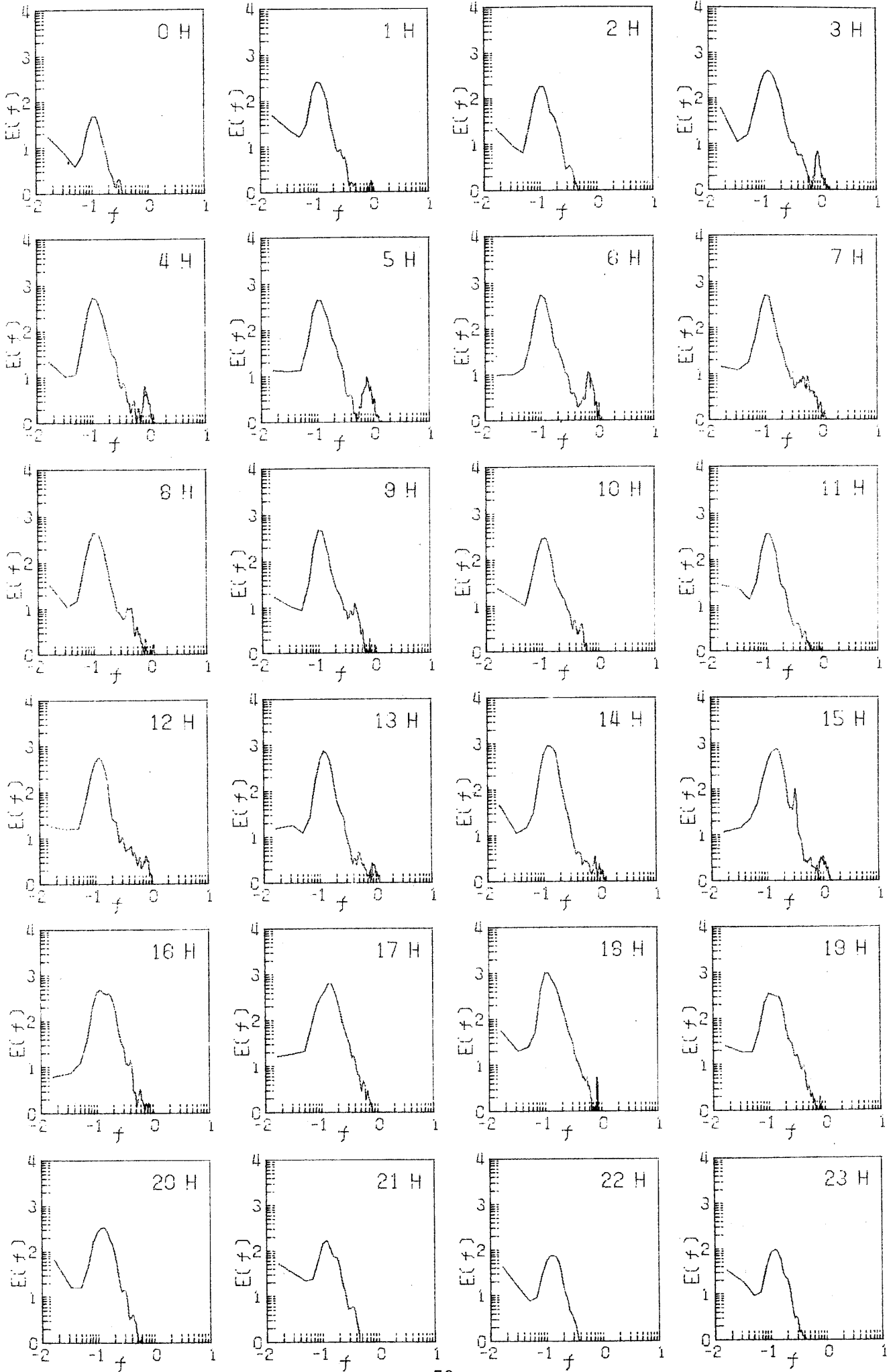

1978 12 15

HOUR	WAVE NUMBER	T (AVE)	H (AVE)	T (1/3)	H (1/3)	T (1/10)	H (1/10)	T (MAX)	H (MAX)
0	120	4.9	9.6	7.5	16.9	7.8	22.1	7.8	29.3
1	99	6.0	19.0	8.0	30.8	8.0	37.1	8.1	48.3
2	99	6.0	23.8	7.6	43.0	7.6	54.7	7.2	59.3
3	98	6.0	30.0	8.2	49.9	8.2	60.7	6.9	71.0
4	106	5.6	32.5	8.2	54.9	8.6	71.0	9.0	87.2
5	108	5.5	32.9	8.2	58.2	7.8	76.4	7.8	95.2
6	90	6.6	40.0	8.4	64.1	8.6	79.8	8.7	96.7
7	115	5.1	30.6	8.9	56.6	9.1	75.7	8.1	109.9
8	92	6.5	39.6	8.7	66.3	8.6	84.0	8.7	101.1
9	104	5.7	34.9	8.4	58.5	8.7	69.9	9.0	78.7
10	126	4.7	20.1	8.2	38.1	8.8	53.7	8.4	72.5
11	88	6.8	32.1	8.7	52.3	8.2	68.1	8.4	84.2
12	114	5.2	25.6	8.3	45.8	8.6	60.6	9.0	78.7
13	103	5.8	38.3	8.5	65.0	8.9	81.0	7.5	105.1
14	104	5.7	35.5	8.4	61.4	8.5	75.0	9.0	82.0
15	92	6.5	43.6	8.5	70.1	8.4	87.0	8.7	101.8
16	110	5.4	32.2	8.0	60.7	8.1	79.8	8.7	100.3
17	95	6.2	36.1	8.3	60.6	8.1	78.3	6.6	85.0
18	104	5.6	30.8	8.2	51.6	8.2	61.6	8.1	66.7
19	114	5.1	26.2	8.3	46.1	8.7	59.1	8.1	75.4
20	95	6.2	16.4	9.0	31.1	9.2	41.4	9.6	48.4
21	78	7.5	25.8	8.9	36.6	9.1	42.3	8.7	50.9
22	96	6.2	10.7	8.4	19.5	7.8	26.9	8.4	32.2
23	82	7.2	17.2	8.8	29.1	8.9	37.2	8.4	42.8

STOP 0

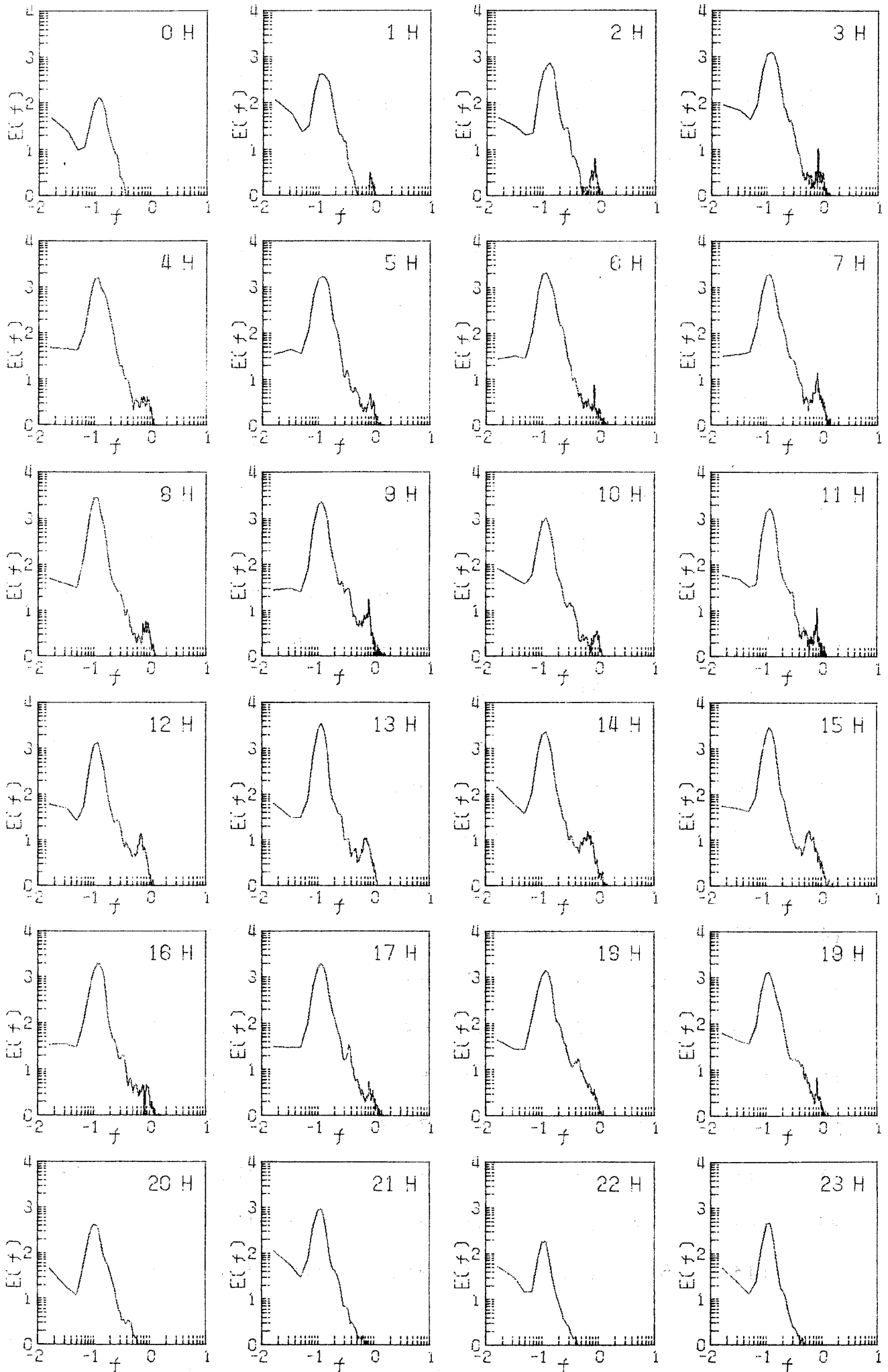

1978 12 16

HOUR	WAVE NUMBER	T (AVE)	H (AVE)	T (1/3)	H (1/3)	T (1/10)	H (1/10)	T (MAX)	H (MAX)
0	111	5.3	8.2	8.1	15.9	8.4	21.1	7.5	26.4
1	97	6.1	8.2	8.6	13.8	8.0	17.8	8.4	20.9
2	102	5.6	14.9	8.4	30.0	8.5	34.3	8.1	37.0
3	93	6.4	14.1	8.1	26.3	7.8	35.2	9.0	47.2
4	115	5.2	21.8	8.4	40.0	8.8	51.8	9.6	65.6
5	115	5.1	23.8	8.1	43.6	8.5	57.0	9.0	72.9
6	111	5.4	25.0	8.6	44.8	9.0	59.9	8.7	80.9
7	105	5.6	23.7	8.5	40.8	9.4	52.3	8.4	82.4
8	132	4.5	21.1	7.4	38.1	8.6	49.0	7.5	57.9
9	94	6.3	29.0	9.3	49.4	9.4	60.9	9.3	74.7
10	106	5.6	21.3	8.4	38.1	8.4	50.8	7.5	55.3
11	90	6.5	21.9	9.0	41.1	9.4	54.4	9.6	72.1
12	73	8.0	28.1	9.6	46.5	9.3	58.4	9.3	67.4
13	74	8.0	32.3	9.1	50.9	8.7	64.5	9.0	87.2
14	87	6.8	32.1	8.4	49.2	8.7	57.5	8.1	61.5
15	119	5.0	30.9	8.0	55.1	7.6	69.0	7.8	79.8
16	135	4.4	37.3	7.4	65.2	8.8	83.6	7.5	100.7
17	130	4.6	38.0	7.7	63.3	8.3	78.9	9.0	104.4
18	145	4.1	37.3	6.4	59.8	8.2	76.3	9.3	100.3
19	170	3.5	31.8	5.1	50.2	5.8	63.9	9.0	94.5
20	120	4.9	20.2	7.9	35.4	8.5	48.2	8.7	58.6
21	115	5.1	16.3	8.0	26.1	8.2	32.2	7.5	39.2
22	102	5.7	16.6	8.4	27.1	8.6	35.7	8.4	45.4
23	116	5.1	13.9	7.9	25.8	8.5	36.0	6.6	49.8

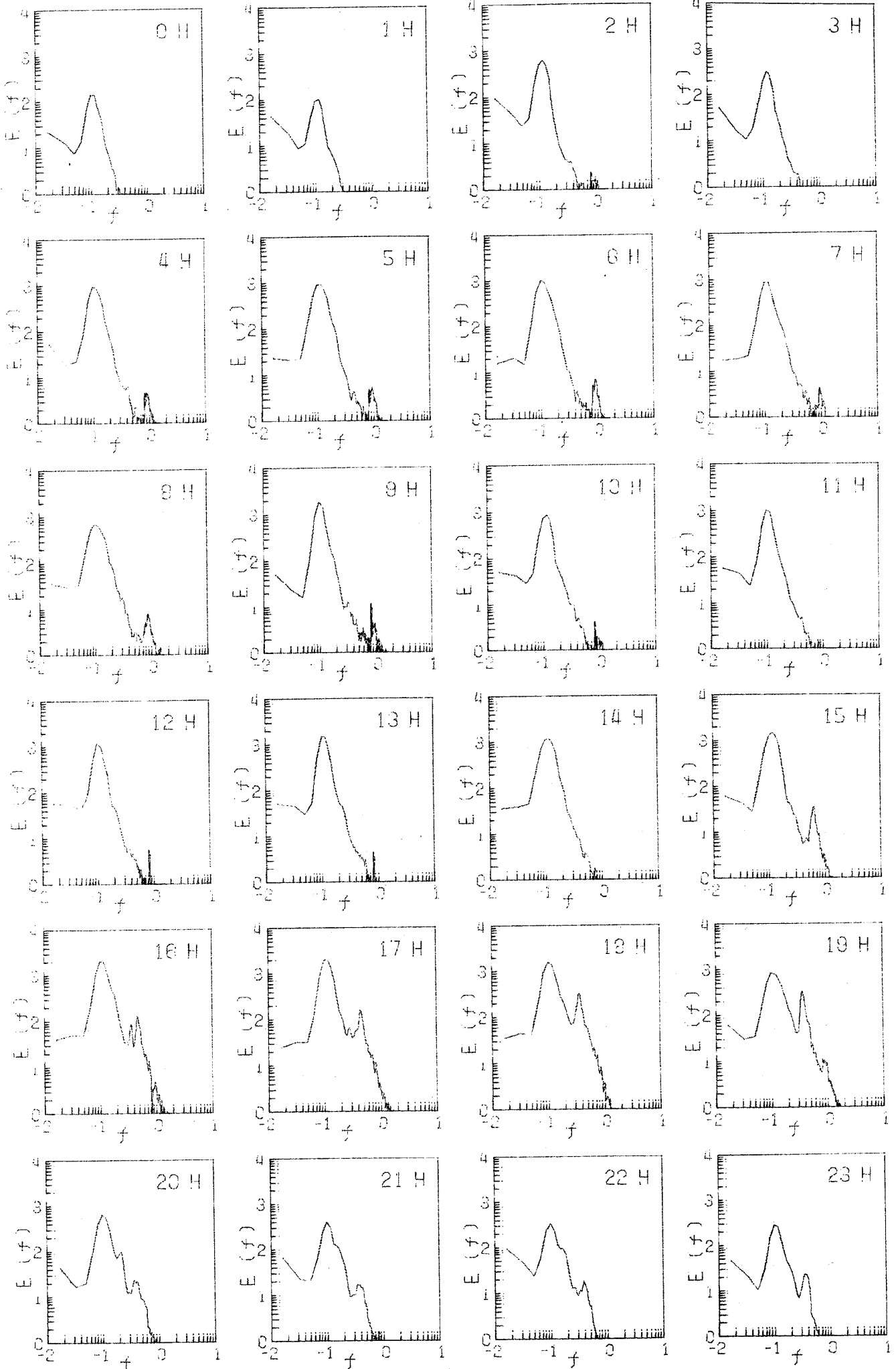

1978 12 17

HOUR	WAVE NUMBER	T (AVE)	H (AVE)	T (1/3)	H (1/3)	T (1/10)	H (1/10)	T (MAX)	H (MAX)
0	145	4.1	10.2	6.7	17.9	8.7	25.9	7.5	41.4
1	127	4.7	8.5	8.3	16.2	8.7	23.1	8.1	28.6
2	103	5.7	14.5	8.9	24.8	9.0	31.5	9.3	41.0
3	116	5.1	11.0	7.8	20.5	8.8	26.7	9.6	32.2
4	136	4.3	16.8	7.1	27.8	8.3	37.1	9.6	49.8
5	127	4.7	20.9	7.7	36.4	8.8	48.5	11.4	60.1
6	141	4.2	18.2	7.0	32.5	8.9	43.0	8.1	67.4
7	126	4.7	20.8	8.0	38.0	9.6	52.2	10.5	69.6
8	114	5.2	22.8	8.1	37.7	8.5	44.2	8.4	56.0
9	115	5.1	25.1	8.0	43.7	8.8	59.2	9.3	63.7
10	96	6.1	33.1	8.7	50.5	9.6	62.1	9.6	69.2
11	109	5.4	26.8	7.4	41.6	7.6	53.1	8.4	65.2
12	96	6.2	27.3	8.6	43.6	9.2	57.7	9.9	75.4
13	104	5.7	31.5	7.5	48.2	7.4	60.9	6.0	69.9
14	96	6.2	38.5	7.7	56.3	6.6	66.7	9.3	85.0
15	102	5.8	39.4	7.5	63.5	8.2	78.5	6.0	93.4
16	109	5.5	36.6	7.9	59.3	7.2	74.2	6.9	90.8
17	112	5.3	38.5	6.8	60.9	7.6	77.3	6.3	122.3
18	108	5.5	40.8	6.5	64.5	6.9	82.8	6.6	92.3
19	121	4.9	33.1	6.7	56.6	6.3	72.8	6.3	88.3
20	121	4.9	36.7	6.7	57.1	6.6	69.6	5.7	85.3
21	111	5.4	28.7	6.2	48.2	6.6	64.4	6.3	83.1
22	109	5.5	27.8	6.8	41.1	6.5	54.0	5.7	65.6
23	108	5.5	19.3	6.8	30.9	6.9	40.6	7.5	50.9

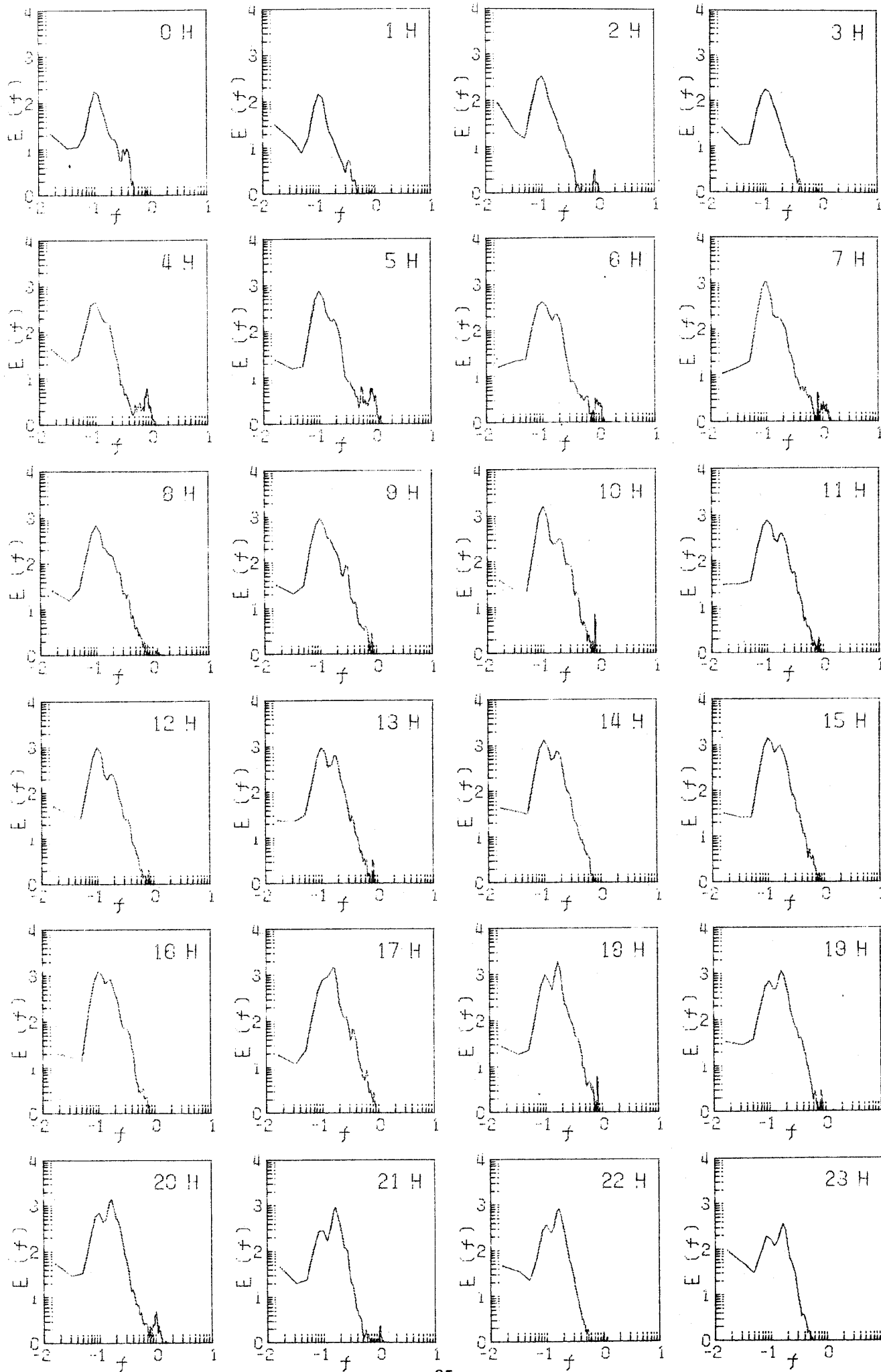

1978 12 18

HOUR	WAVE NUMBER	T (AVE)	H (AVE)	T (1/3)	H (1/3)	T (1/10)	H (1/10)	T (MAX)	H (MAX)
0	107	5.5	23.4	6.2	40.9	6.7	56.9	5.7	76.5
1	93	6.4	17.1	7.5	27.3	7.3	34.9	6.3	43.9
2	102	5.8	17.0	7.4	26.8	6.8	31.0	5.7	38.1
3	112	5.3	16.3	7.9	25.8	8.1	31.5	8.1	36.6
4	132	4.5	14.8	7.0	25.4	7.8	32.8	8.7	38.1
5	138	4.3	20.1	7.2	34.8	7.4	44.9	7.2	58.6
6	146	4.1	21.1	7.1	38.0	8.0	50.3	8.7	62.5
7	161	3.7	21.0	6.5	36.1	8.1	48.5	7.8	62.5
8	137	4.4	21.1	7.4	37.4	9.9	51.0	10.8	65.5
9	142	4.2	21.4	8.1	38.4	10.2	49.2	9.0	57.9
10	143	4.1	19.4	7.6	34.1	9.7	46.0	10.2	64.1
11	157	3.8	13.8	6.9	23.8	8.5	32.2	9.0	46.1
12	113	5.2	15.1	9.4	29.0	9.7	39.2	9.6	57.5
13	101	5.9	17.2	8.7	30.0	9.6	38.5	9.9	48.3
14	112	5.3	19.8	8.8	34.2	10.7	42.9	10.5	46.5
15	142	4.2	19.9	7.7	36.7	9.3	50.2	10.5	66.3
16	152	3.9	20.7	6.7	37.1	8.7	51.9	9.6	64.5
17									
18	181	3.3	18.0	5.9	31.0	8.2	43.6	9.6	65.9
19	183	3.2	16.9	5.8	28.8	7.9	40.5	7.2	52.0
20	170	3.5	17.6	5.9	29.6	7.7	38.7	9.6	53.1
21	156	3.8	14.5	6.8	24.9	8.5	32.9	9.6	49.4
22	131	4.5	13.2	7.9	23.1	9.3	29.6	9.3	37.7
23	139	4.2	12.2	8.1	21.6	9.3	27.0	7.8	31.5

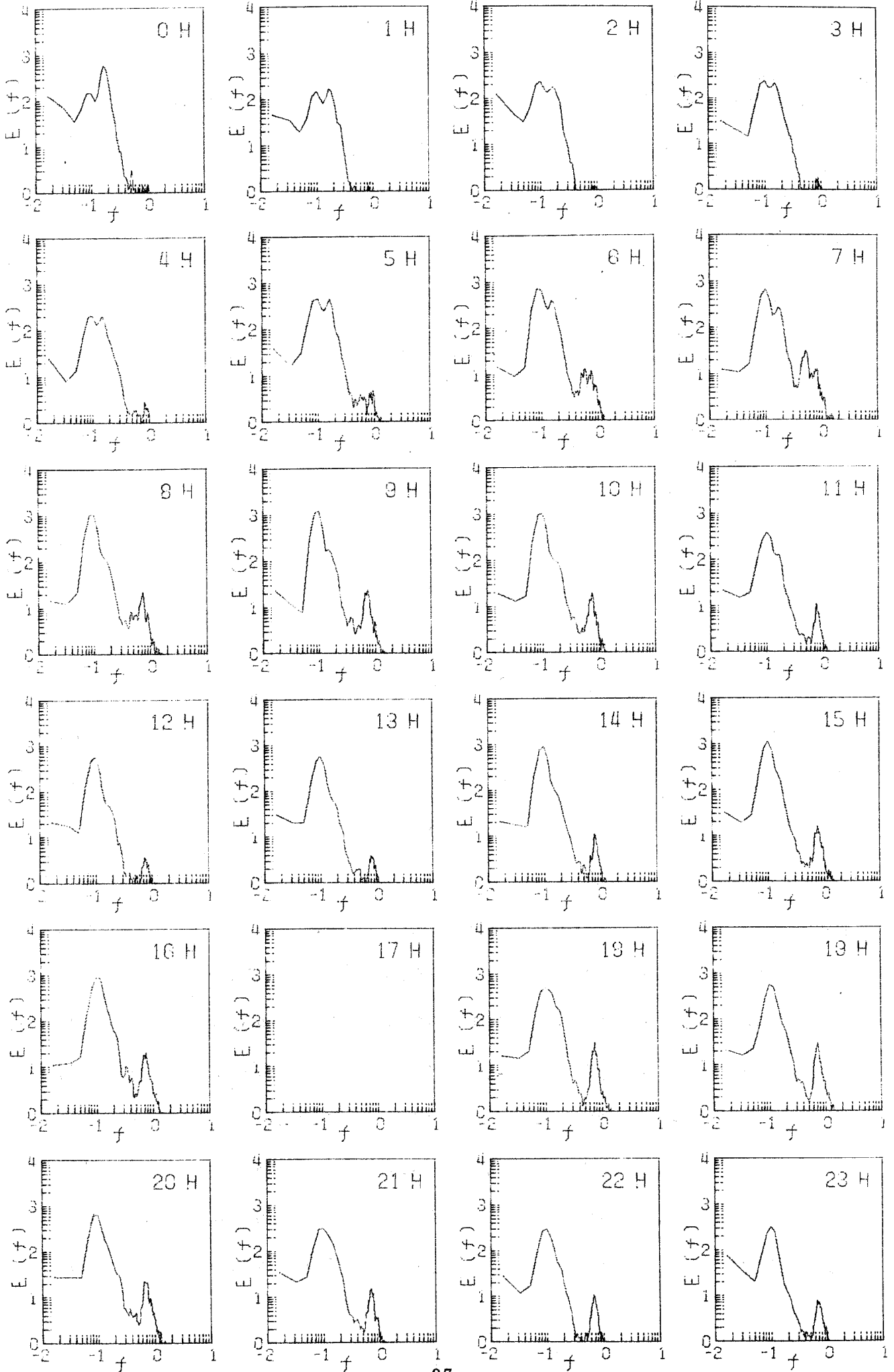

1978 12 19

HOUR	WAVE NUMBER	T (AVE)	H (AVE)	T (1/3)	H (1/3)	T (1/10)	H (1/10)	T (MAX)	H (MAX)
0	121	4.8	7.3	8.1	12.7	8.5	18.1	7.5	24.2
1	103	5.8	10.5	8.9	18.8	8.5	26.3	7.2	31.5
2	131	4.5	9.3	7.5	16.4	8.2	22.2	7.8	30.8
3	164	3.6	11.5	6.6	18.3	9.0	23.8	9.9	27.1
4	145	4.1	11.8	7.8	25.1	9.5	41.5	9.0	51.6
5	150	4.0	17.2	7.2	29.5	8.5	38.2	8.4	60.8
6	134	4.4	23.9	8.0	43.5	9.2	59.4	9.0	69.9
7	145	4.1	19.2	6.9	32.7	8.0	43.3	7.2	67.0
8	154	3.9	22.2	6.9	39.7	9.0	58.9	9.0	75.1
9	149	4.0	22.2	7.4	41.8	9.2	60.4	9.0	87.5
10	128	4.6	27.2	7.8	46.3	8.8	56.8	9.6	71.4
11	133	4.5	23.5	7.6	42.0	8.8	54.5	9.3	65.9
12	150	3.9	21.7	6.8	37.6	8.4	51.9	7.8	80.6
13	178	3.3	23.3	5.9	40.7	8.2	57.0	9.6	79.5
14	174	3.4	24.3	6.2	41.6	8.2	57.9	8.1	77.3
15	140	4.3	25.0	7.5	43.9	8.9	59.7	9.0	88.3
16	147	4.0	24.9	6.8	42.5	9.0	57.7	8.4	69.9
17	163	3.6	20.8	6.2	35.4	8.2	49.8	9.6	68.8
18	194	3.1	19.7	5.1	32.2	7.3	45.8	9.3	69.6
19	207	2.9	20.3	4.5	32.0	6.6	42.7	8.1	67.0
20	174	3.4	22.1	5.9	37.9	7.9	55.6	9.0	75.4
21	152	3.9	27.9	6.3	44.2	8.4	59.5	7.2	79.1
22	149	4.0	25.4	6.9	45.1	8.8	60.4	9.6	89.0
23	207	2.9	17.8	4.9	29.8	7.0	42.4	9.9	63.7

1978 12 20

HOUR	WAVE NUMBER	T (AVE)	H (AVE)	T (1/3)	H (1/3)	T (1/10)	H (1/10)	T (MAX)	H (MAX)
0	176	3.4	18.1	5.7	29.6	8.1	38.9	9.9	46.5
1	193	3.1	17.2	5.1	27.7	7.3	37.5	7.8	52.4
2	171	3.5	18.7	5.8	31.7	8.5	40.8	9.3	53.8
3	179	3.3	18.3	5.7	30.2	8.3	41.5	9.6	48.3
4	192	3.1	15.7	5.4	26.8	8.0	38.9	9.0	54.6
5	143	4.2	18.8	7.4	32.9	8.4	42.8	9.6	68.7
6	163	3.6	15.9	6.5	27.2	9.0	38.0	8.1	57.5
7	175	3.3	16.4	5.8	26.3	8.0	34.1	6.9	41.7
8	198	3.0	15.9	4.9	26.0	7.1	36.5	9.9	52.7
9	172	3.5	14.8	6.4	25.4	8.2	32.8	9.0	43.9
10	129	4.6	20.6	7.5	36.5	9.0	51.2	10.2	60.8
11	131	4.5	23.0	7.9	40.9	9.3	54.5	9.6	80.6
12	119	5.0	26.3	8.7	45.8	10.0	57.9	9.9	68.9
13	114	5.2	23.7	8.5	43.0	9.3	56.6	9.0	76.2
14	94	6.3	28.6	9.2	46.4	9.4	59.4	9.3	69.2
15	102	5.7	29.5	9.1	55.0	9.4	73.6	9.6	84.6
16	139	4.3	27.3	7.4	47.3	8.0	59.0	9.0	67.0
17	137	4.3	24.1	7.6	44.7	9.3	60.5	7.5	76.9
18	133	4.5	27.4	8.2	50.8	9.5	66.5	8.7	85.0
19	131	4.5	30.2	8.2	57.0	9.8	78.7	10.8	96.7
20	125	4.7	28.8	8.1	49.2	9.6	61.6	8.7	80.9
21	146	4.1	25.8	7.6	45.7	9.0	64.6	9.3	76.9
22	94	6.3	36.4	10.1	63.2	9.8	76.1	9.6	89.7
23	101	5.9	31.0	9.3	54.2	9.5	66.7	9.9	86.4

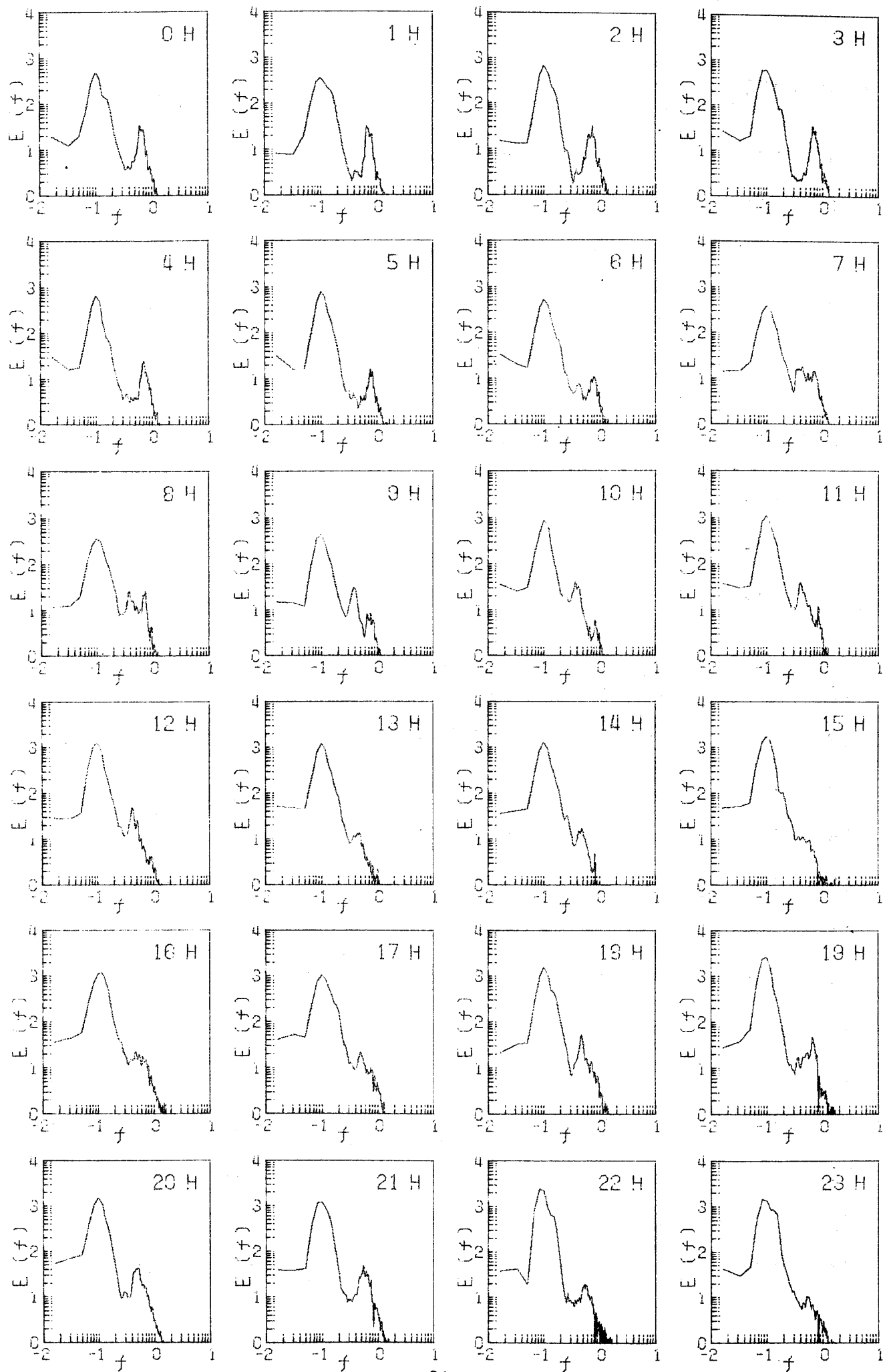

1978 12 21

HOUR	WAVE NUMBER	T (AVE)	H (AVE)	T (1/3)	H (1/3)	T (1/10)	H (1/10)	T (MAX)	H (MAX)
0	121	4.9	26.3	8.0	46.7	8.5	58.7	8.4	80.2
1	111	5.3	26.6	9.0	47.6	9.7	58.8	9.3	69.9
2	110	5.4	26.9	8.7	46.5	9.5	59.0	13.2	68.5
3	117	5.0	23.4	8.6	43.4	9.5	52.2	8.7	60.1
4	100	5.9	24.3	8.3	42.9	9.1	54.1	10.2	80.2
5	133	4.5	20.1	7.6	36.7	7.7	47.8	7.2	76.5
6	104	5.7	27.1	7.9	45.4	8.6	57.9	8.1	77.6
7	134	4.5	23.3	7.2	41.0	9.0	55.5	7.8	72.1
8	104	5.6	30.0	8.3	53.4	9.3	71.9	8.1	112.4
9	99	6.0	32.8	8.4	56.4	8.9	70.7	8.7	85.7
10	105	5.7	30.1	8.5	50.7	8.8	62.8	10.5	67.7
11	105	5.7	30.9	8.2	52.4	8.3	66.0	9.9	85.3
12	105	5.6	29.6	7.9	49.1	8.2	64.9	7.2	82.4
13	127	4.7	25.0	7.0	42.2	7.2	52.6	7.2	62.3
14	167	3.5	19.1	5.6	31.2	6.4	40.4	6.3	54.6
15	160	3.7	19.0	6.0	31.4	7.2	39.8	6.9	53.1
16	138	4.3	24.3	6.6	41.8	7.5	56.7	8.7	64.5
17	130	4.5	22.4	7.3	37.8	7.9	48.1	8.4	65.6
18	120	5.0	22.1	7.9	38.5	8.6	50.9	7.2	65.6
19	105	5.6	26.6	8.6	43.9	9.0	52.3	10.5	59.0
20	104	5.7	28.3	8.6	48.6	8.3	61.8	7.8	80.6
21	127	4.7	22.0	7.7	39.7	9.0	56.3	8.1	80.9
22	127	4.7	20.9	7.7	37.0	9.0	48.6	8.4	67.4
23	121	4.9	20.3	8.5	35.6	9.5	46.1	9.6	60.1

1978 12 22

HOUR	WAVE NUMBER	T (AVE)	H (AVE)	T (1/3)	H (1/3)	T (1/10)	H (1/10)	T (MAX)	H (MAX)
0	136	4.4	17.5	7.6	32.1	8.9	41.8	9.6	46.5
1	144	4.1	15.3	7.2	27.8	8.5	38.9	7.8	50.9
2	131	4.6	15.9	7.8	27.1	8.4	33.8	8.4	39.6
3	130	4.6	17.0	8.3	31.3	9.3	39.4	9.6	51.3
4	113	5.2	17.6	8.7	31.3	8.9	39.6	9.6	46.5
5	133	4.5	15.2	8.1	28.2	9.0	35.9	9.3	52.0
6	138	4.3	15.8	7.4	28.1	8.7	38.5	7.5	51.6
7	165	3.6	15.3	6.1	27.6	7.6	37.2	5.7	44.3
8	147	4.0	18.6	6.4	31.8	7.7	42.8	8.7	50.2
9	147	4.0	19.0	6.5	32.5	8.2	41.6	6.3	50.5
10	150	3.9	17.7	6.6	32.5	8.7	45.5	7.8	69.9
11	168	3.5	16.9	6.5	29.2	8.3	39.9	9.0	57.1
12	138	4.3	17.4	7.9	31.3	9.0	38.9	11.1	45.8
13	123	4.8	19.5	7.7	33.9	8.7	43.9	11.1	56.4
14	157	3.8	15.2	6.7	27.4	8.4	37.2	9.0	50.2
15	104	5.6	23.7	8.1	38.7	8.8	47.8	9.9	57.1
16	131	4.6	16.0	7.8	28.1	8.7	36.2	10.8	53.1
17	121	4.9	18.9	7.9	32.7	9.2	45.2	9.0	61.5
18	122	4.9	17.4	7.9	29.0	8.1	34.3	8.4	40.3
19	138	4.3	17.6	7.1	31.5	8.1	43.6	8.1	54.6
20	124	4.8	18.7	8.2	34.6	8.6	47.1	9.9	60.4
21	107	5.5	22.2	8.6	38.7	9.7	51.2	10.5	65.6
22	134	4.4	17.2	7.8	30.6	9.0	41.8	9.9	62.6
23	118	5.1	20.8	8.5	37.6	9.4	46.7	9.6	51.3

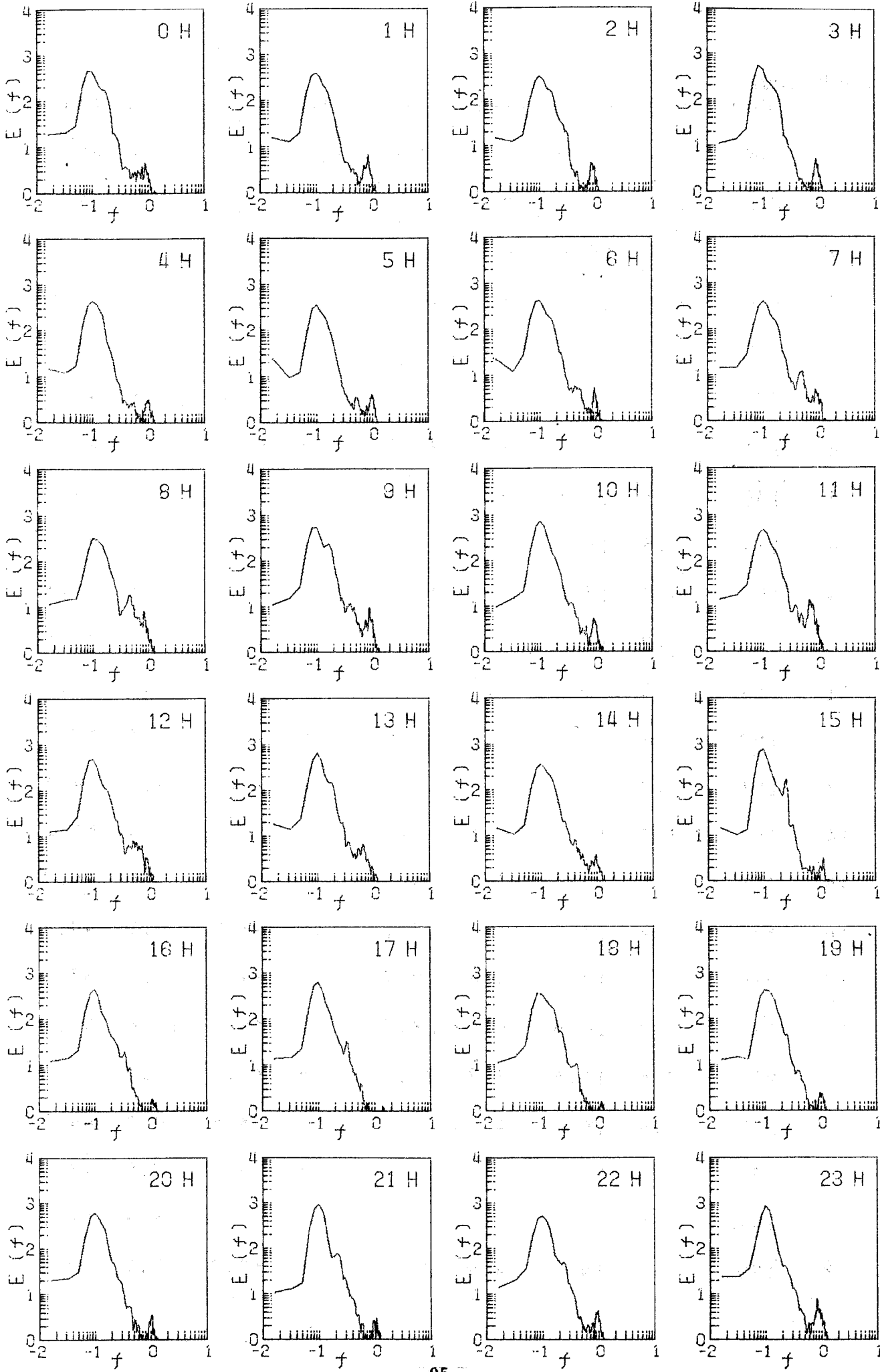

1978 12 23

HOUR	WAVE NUMBER	T	H	T	H	T	H	T	H
		(AVE)	(AVE)	(1/3)	(1/3)	(1/10)	(1/10)	(MAX)	(MAX)
0	146	4.0	15.9	7.4	29.4	8.7	40.0	7.8	45.4
1	144	4.1	15.2	7.9	29.4	9.3	40.4	8.7	55.3
2	130	4.6	15.3	8.8	29.6	9.6	39.0	9.3	48.0
3	119	5.0	15.6	8.6	27.4	9.8	35.8	9.6	49.8
4	115	5.1	17.3	9.2	32.1	10.3	41.2	10.5	51.3
5	137	4.3	13.7	8.1	25.3	10.2	36.4	9.3	46.1
6	141	4.2	14.0	7.4	25.5	8.9	35.7	8.7	49.4
7	135	4.3	15.6	8.2	29.4	9.7	39.2	10.8	49.8
8	131	4.5	16.6	7.7	29.4	8.9	39.1	9.3	48.3
9	150	4.0	17.4	6.8	31.5	8.7	43.3	9.6	55.3
10	143	4.2	17.7	7.5	31.8	9.7	42.7	9.0	54.6
11	169	3.5	17.7	6.7	32.6	9.8	48.8	10.5	68.1
12	162	3.7	16.3	6.7	28.6	8.6	40.1	9.3	59.7
13	141	4.2	17.2	7.6	30.1	9.1	42.6	9.0	64.1
14	183	3.3	15.4	5.8	26.5	8.0	36.7	8.4	50.2
15	225	2.6	17.2	3.6	25.9	5.6	33.0	10.5	44.7
16	250	2.4	17.2	3.5	27.1	4.7	34.9	8.1	49.8
17	215	2.8	17.8	4.4	28.7	5.7	39.8	10.2	57.5
18	197	3.0	14.6	5.0	23.7	7.6	35.8	10.8	67.4
19	236	2.5	14.6	3.7	23.9	5.5	32.5	10.2	49.8
20	208	2.9	16.3	4.2	26.0	5.0	33.6	9.0	44.7
21	226	2.6	15.5	3.7	23.9	4.3	29.8	7.5	40.3
22	247	2.4	14.1	3.2	22.2	4.2	28.9	6.9	42.1
23	199	3.0	14.2	4.9	22.2	6.8	30.0	8.1	39.9

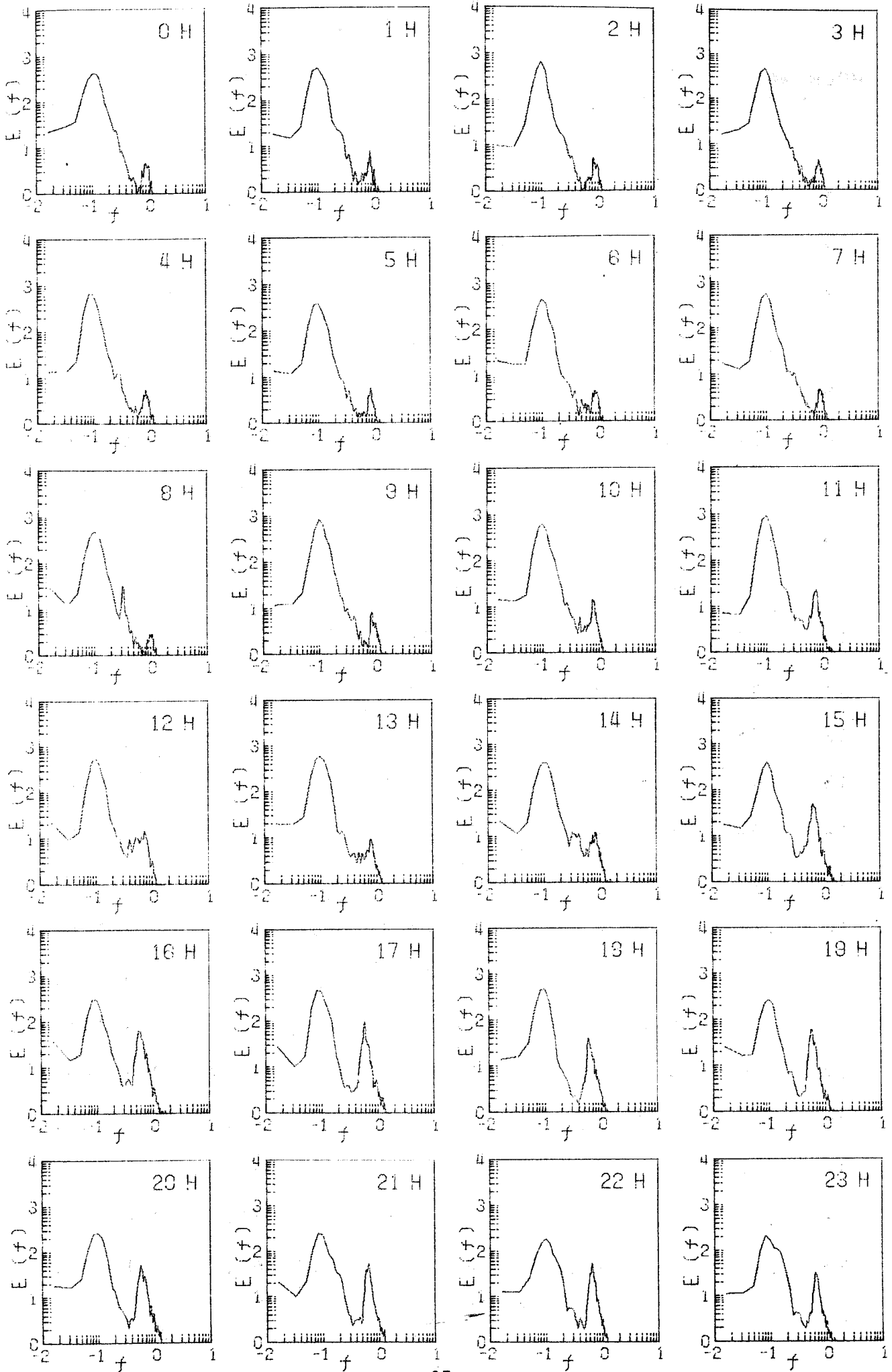

1978 12 24

HOUR	WAVE NUMBER	T (AVE)	H (AVE)	T (1/3)	H (1/3)	T (1/10)	H (1/10)	T (MAX)	H (MAX)
0	184	3.2	12.0	5.6	18.8	7.6	23.7	8.7	33.3
1	196	3.0	10.2	5.8	18.3	8.5	26.7	9.0	45.4
2	163	3.7	8.7	6.1	14.8	8.0	20.9	10.2	27.8
3	148	4.0	9.3	7.2	17.2	8.9	23.9	12.3	28.9
4	125	4.8	10.6	7.9	18.9	8.5	24.0	7.8	30.4
5	118	5.0	15.2	8.1	26.4	7.9	34.7	8.4	46.5
6	113	5.2	21.6	7.8	36.6	8.0	44.7	8.4	53.5
7	138	4.2	19.3	7.0	34.2	7.9	45.7	8.1	57.1
8	100	5.9	30.4	8.2	50.8	8.5	65.4	8.7	80.2
9	95	6.3	41.4	8.9	70.8	8.7	91.8	8.4	106.2
10	93	6.4	41.7	8.8	71.5	8.4	93.3	7.8	119.2
11	87	6.8	41.9	9.1	65.6	9.4	85.1	8.4	101.4
12	93	6.3	38.6	8.3	62.9	9.0	75.7	7.5	89.7
13	90	6.6	45.5	8.9	72.4	8.9	85.0	8.4	94.8
14	99	5.9	46.2	8.1	79.2	8.2	97.2	8.7	115.0
15	116	5.1	47.5	7.5	83.9	8.0	112.7	6.9	146.9
16	117	5.1	41.6	7.7	72.9	8.2	92.7	8.7	116.5
17	114	5.2	41.5	7.8	72.6	8.7	85.7	6.9	92.3
18	118	5.0	38.6	7.7	66.6	8.2	88.8	8.4	111.7
19	125	4.7	32.4	8.3	60.3	9.3	76.7	7.8	89.4
20	104	5.7	32.2	8.5	55.5	8.7	69.4	9.9	84.2
21	111	5.4	28.4	8.3	54.3	8.4	68.0	8.4	88.6
22	101	5.8	32.1	8.8	57.8	8.6	71.6	7.8	87.2
23	111	5.3	27.8	8.2	50.5	8.0	60.1	8.1	72.9

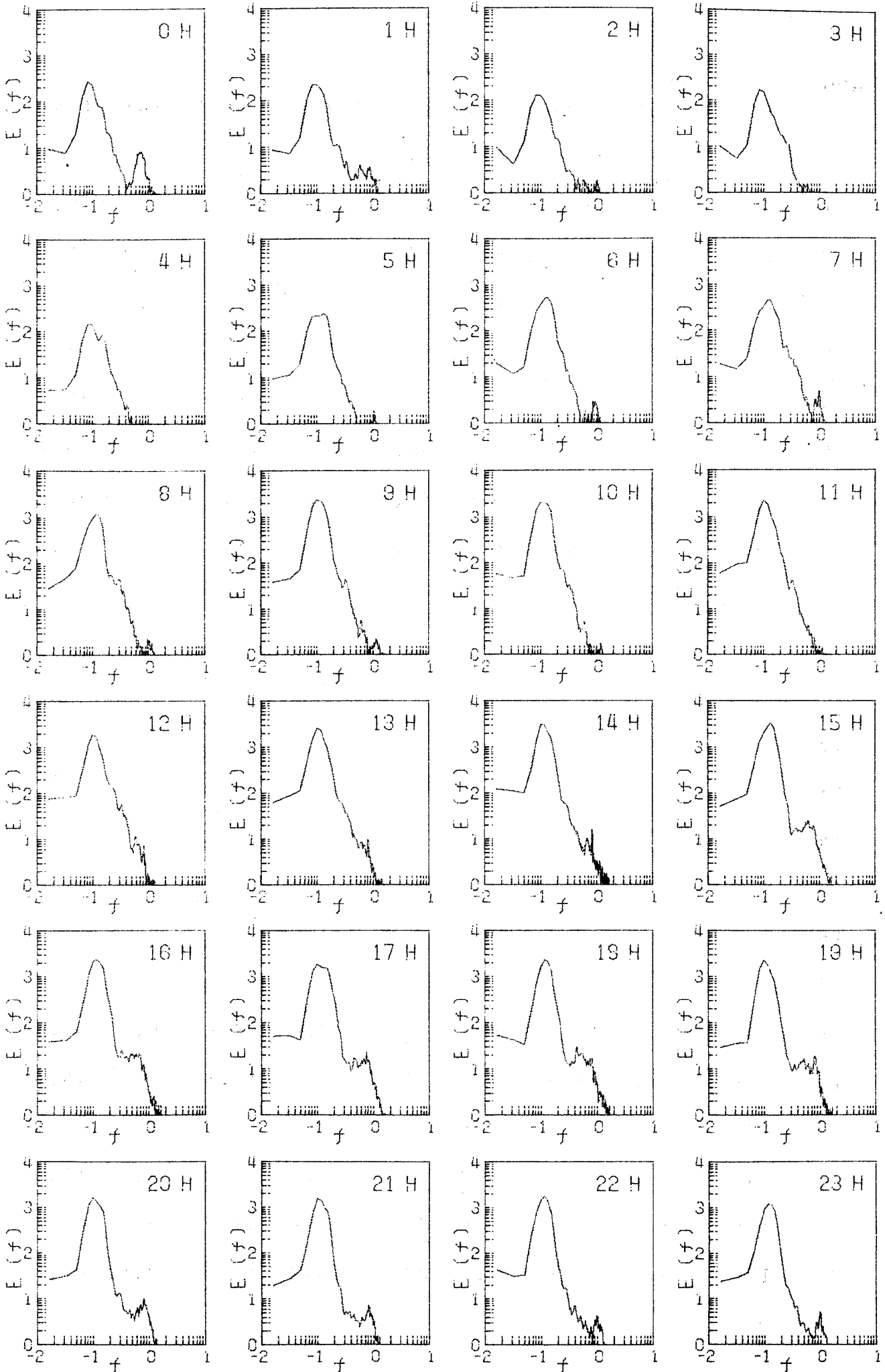

1978 12 25

HOUR	WAVE NUMBER	T (AVE)	H (AVE)	T (1/3)	H (1/3)	T (1/10)	H (1/10)	T (MAX)	H (MAX)
0	96	6.1	32.7	8.3	55.0	8.5	70.4	9.3	85.0
1	121	4.9	24.6	7.3	43.4	7.2	55.6	6.9	78.4
2	156	3.8	19.9	6.7	37.3	7.7	52.0	7.8	64.5
3	138	4.3	19.5	7.4	35.6	7.6	47.3	7.8	62.6
4	112	5.3	20.9	7.3	37.7	7.9	46.6	8.1	53.8
5	102	5.8	25.7	7.2	40.1	7.3	51.9	7.8	65.2
6	132	4.5	20.2	7.3	36.4	7.8	47.5	7.8	69.2
7	140	4.2	19.9	6.8	35.3	6.9	46.2	7.2	60.4
8	145	4.1	20.9	6.9	38.1	7.3	53.6	6.9	75.4
9	161	3.7	20.8	6.7	36.8	7.9	47.8	9.6	60.1
10									
11									
12									
13									
14									
15									
16									
17									
18	141	4.2	16.8	6.4	27.7	7.4	33.6	5.7	43.9
19	128	4.7	17.8	7.0	29.4	6.9	37.3	6.9	46.9
20	131	4.5	16.2	7.3	28.0	7.8	35.2	6.9	40.6
21	145	4.1	14.3	6.7	23.3	7.0	28.9	5.4	39.9
22	155	3.8	13.1	6.4	24.2	7.4	31.2	8.4	41.0
23	178	3.4	13.6	5.7	23.2	6.9	30.2	7.8	42.8

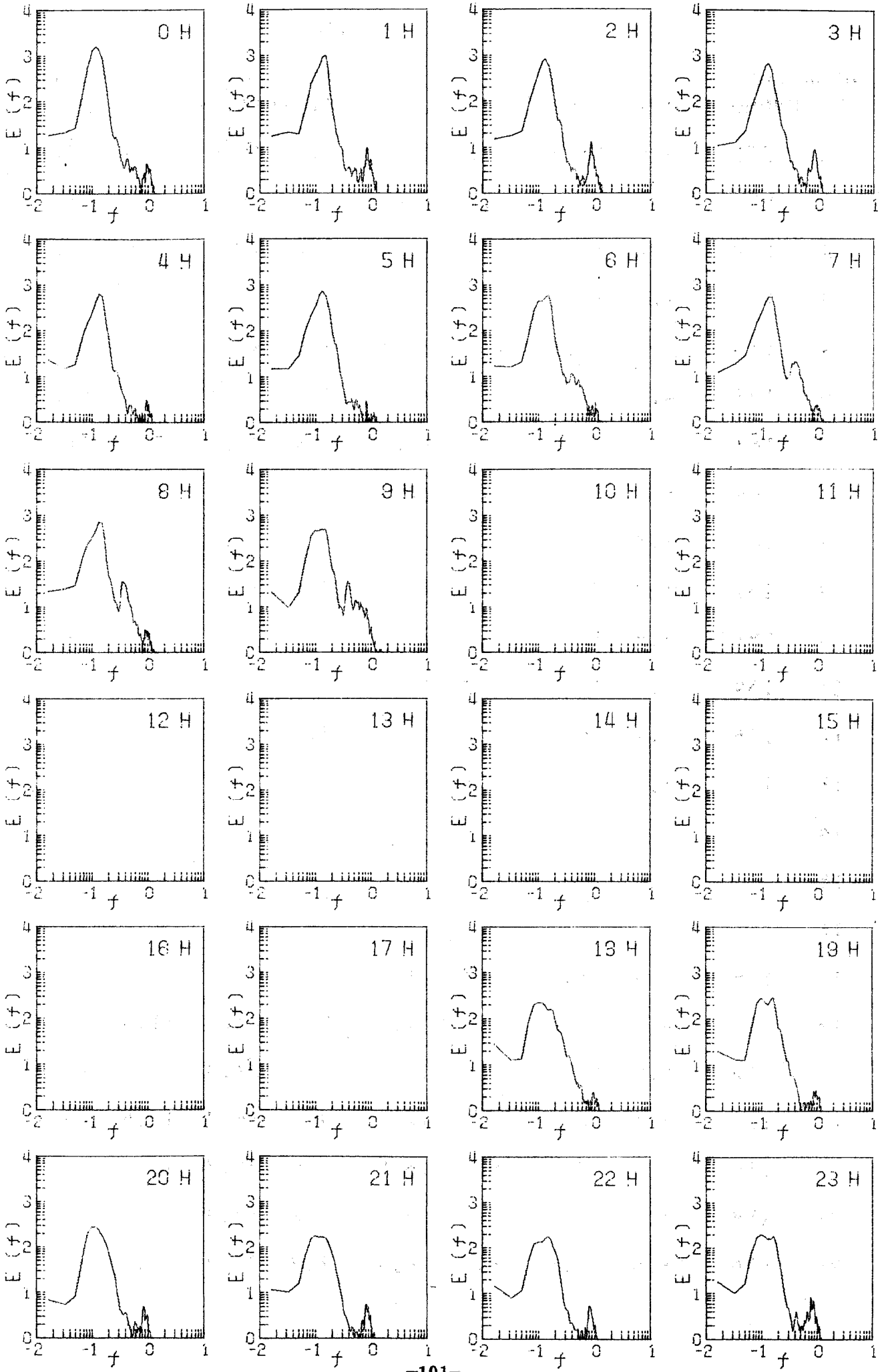

1978 12 26

HOUR	WAVE NUMBER	T (AVE)	H (AVE)	T (1/3)	H (1/3)	T (1/10)	H (1/10)	T (MAX)	H (MAX)
0	172	3.5	15.5	6.2	27.2	8.0	35.9	8.4	47.2
1	125	4.7	21.4	7.8	37.6	8.7	48.7	9.6	55.7
2	140	4.2	16.1	7.6	29.9	9.4	42.6	9.0	63.0
3	144	4.1	15.0	7.3	27.3	8.1	39.3	7.8	51.6
4	139	4.3	15.1	7.5	26.3	8.6	34.8	9.9	39.9
5	127	4.6	11.1	8.2	20.8	8.6	29.3	8.4	36.3
6	163	3.7	10.5	6.6	18.0	8.3	23.6	7.5	31.1
7	164	3.6	11.0	6.1	17.5	7.8	22.7	11.4	29.7
8	181	3.3	10.9	5.8	18.4	7.8	24.6	8.7	32.6
9	187	3.2	10.3	5.7	17.4	7.6	25.0	7.2	39.2
10	156	3.8	10.4	6.5	17.5	7.3	21.7	10.2	24.5
11	139	4.2	12.5	6.7	21.6	8.0	27.7	10.5	36.3
12	126	4.7	14.8	7.2	24.8	7.0	30.2	8.1	34.8
13	107	5.5	15.7	8.1	26.9	8.6	34.4	7.8	45.8
14									
15									
16									
17	136	4.4	13.6	6.7	21.4	7.0	27.1	6.9	31.1
18	123	4.8	11.9	7.4	19.5	8.5	23.2	11.4	28.2
19	122	4.8	10.0	7.8	18.3	8.8	23.3	7.5	27.1
20	117	5.1	8.2	7.5	12.9	9.2	16.7	10.5	25.3
21	138	4.3	9.6	6.8	16.2	8.8	20.7	10.8	24.5
22	158	3.8	7.2	6.4	12.7	8.2	17.9	9.6	25.3
23	170	3.5	10.5	6.1	18.9	7.2	25.7	8.1	33.7

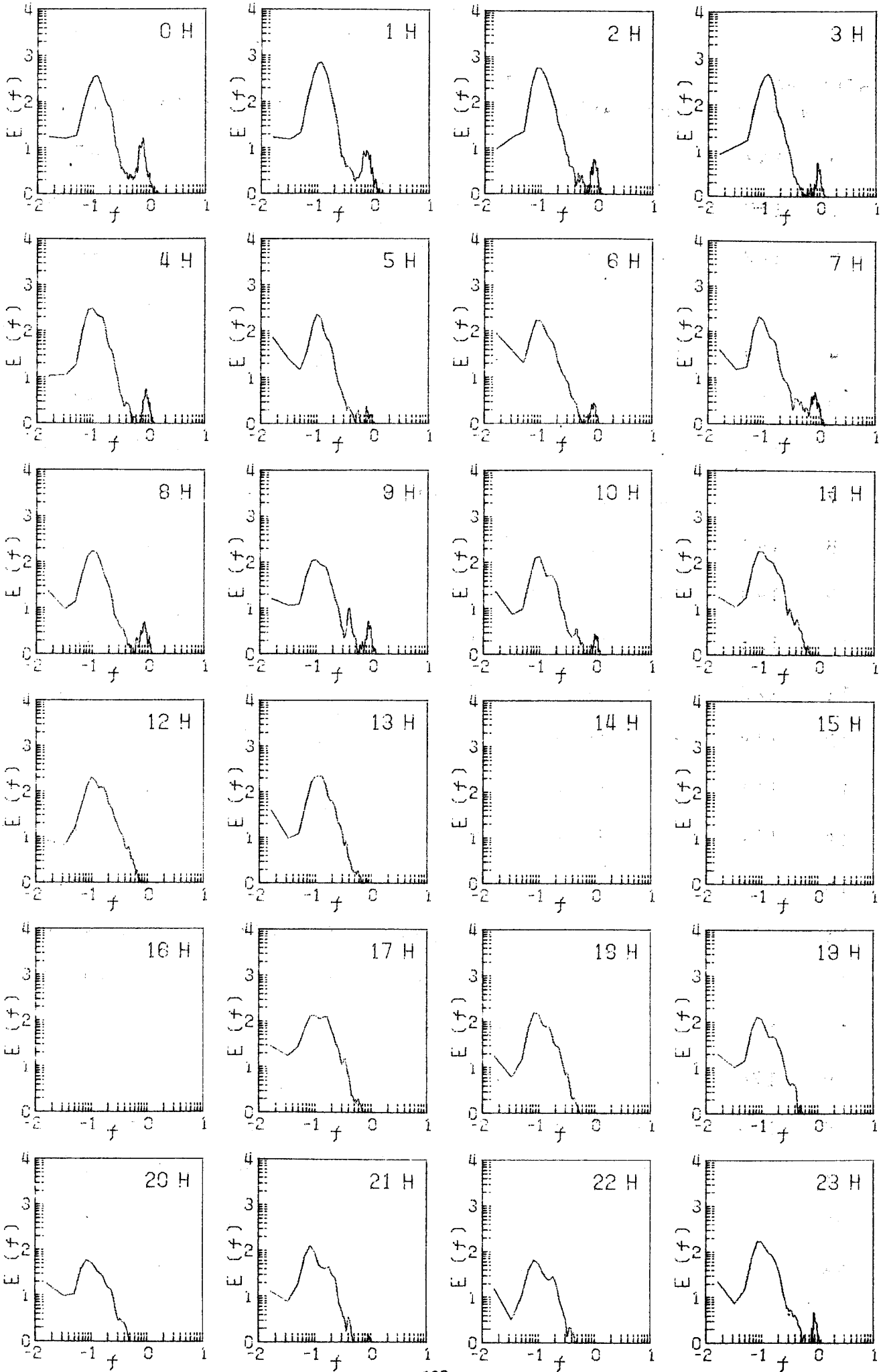

1978 12 27

HOUR	WAVE NUMBER	T (AVE)	H (AVE)	T (1/3)	H (1/3)	T (1/10)	H (1/10)	T (MAX)	H (MAX)
0	143	4.2	13.5	7.2	23.5	8.2	31.2	9.0	47.6
1	132	4.5	15.3	7.4	26.2	8.1	32.9	6.9	39.2
2	122	4.9	15.4	8.0	27.9	9.1	38.8	9.3	48.0
3	147	4.0	12.7	7.7	23.7	9.1	32.1	11.1	39.2
4	174	3.4	11.5	5.9	20.5	7.6	29.5	8.4	50.2
5	167	3.6	12.7	6.5	22.3	8.1	31.0	7.8	40.6
6	154	3.8	14.6	6.7	26.6	9.4	39.2	10.2	60.4
7	147	4.0	17.3	7.5	31.6	9.0	43.9	9.0	55.7
8	140	4.2	15.6	7.3	28.0	8.7	38.5	8.4	53.5
9	140	4.2	15.3	7.6	27.4	9.5	34.7	11.1	43.2
10	123	4.8	16.8	8.3	28.6	9.0	35.2	8.1	42.8
11	122	4.8	14.5	8.2	26.8	9.6	35.5	9.0	48.3
12	118	5.0	16.5	8.0	27.4	9.3	35.1	10.8	44.3
13	141	4.2	15.7	7.2	27.8	8.5	36.5	10.8	48.7
14	164	3.6	22.2	5.9	35.7	7.6	44.7	8.1	53.1
15	203	2.9	33.3	3.7	50.7	4.3	62.0	4.2	73.6
16	209	2.9	36.6	3.5	57.1	3.3	72.3	3.6	97.0
17	207	2.9	37.2	3.4	56.2	3.1	69.9	3.0	105.5
18	183	3.3	33.5	3.9	50.4	3.9	60.7	3.3	68.1
19	176	3.4	33.1	4.2	53.2	3.9	65.4	3.9	80.9
20	169	3.5	25.3	4.2	39.5	4.2	51.8	3.6	70.7
21	143	4.1	18.4	5.0	28.4	5.8	35.5	9.9	47.2
22	136	4.4	16.2	5.8	25.4	6.6	31.4	4.2	37.0
23	155	3.9	15.0	5.8	24.6	7.3	32.0	8.1	47.2

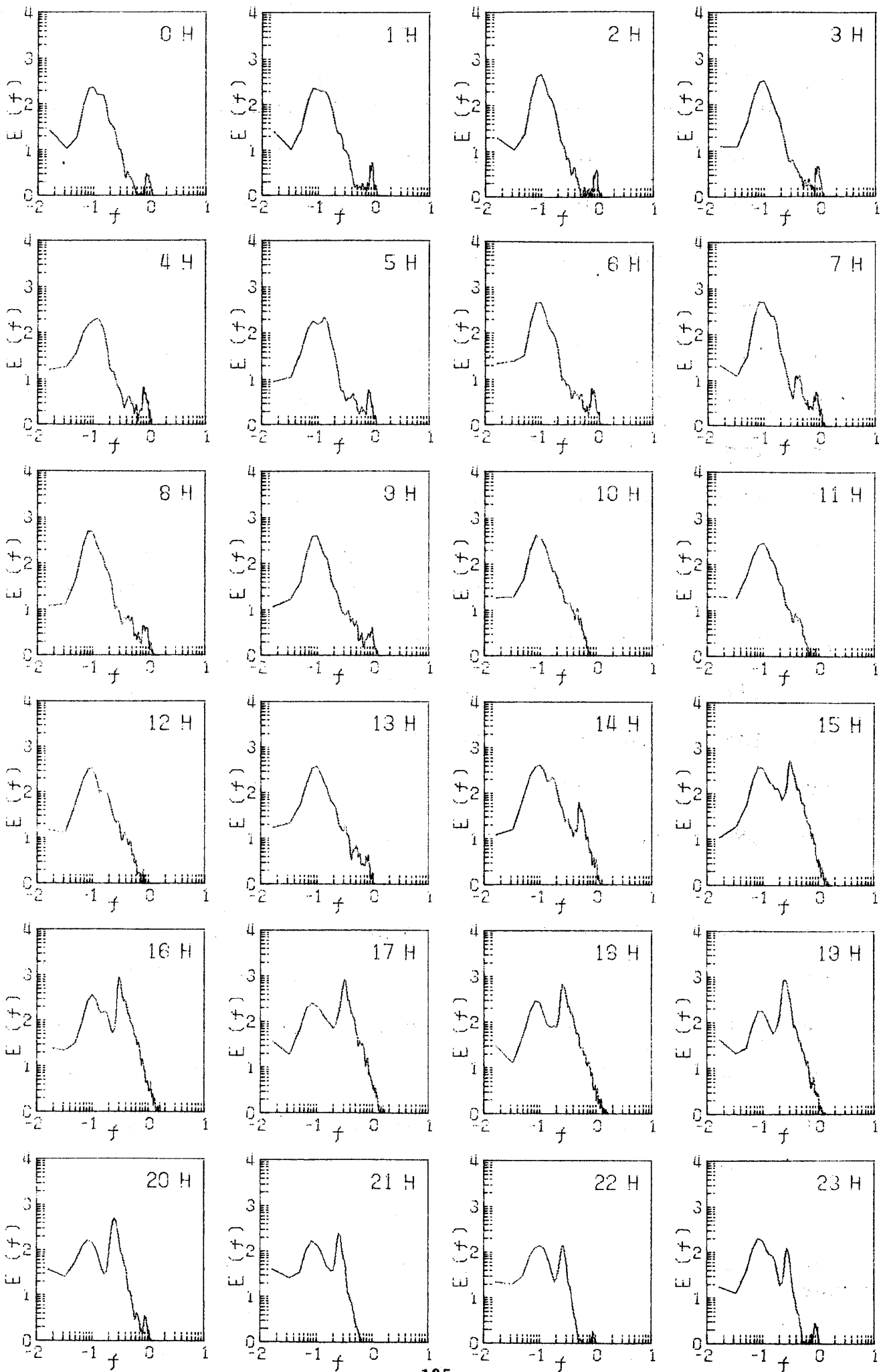

1978 12 28

HOUR	WAVE NUMBER	1978		12		28		T (MAX)	H (MAX)
		T (AVE)	H (AVE)	T (1/3)	H (1/3)	T (1/10)	H (1/10)		
0	160	3.7	16.6	5.3	26.3	6.7	32.3	3.6	37.4
1	136	4.3	20.9	6.1	32.4	6.7	37.9	9.6	43.9
2	132	4.5	23.2	7.0	37.5	8.2	46.7	13.5	59.7
3	141	4.2	22.3	6.9	37.9	8.0	49.1	10.2	68.8
4	146	4.0	20.4	6.9	34.9	9.6	46.7	11.7	59.0
5	158	3.8	18.8	6.6	33.3	10.0	47.4	12.0	64.5
6	138	4.3	18.7	8.0	33.8	11.1	46.9	13.5	66.7
7	118	5.0	19.6	8.3	33.9	12.0	47.6	11.4	57.9
8	96	6.2	24.2	10.0	43.6	10.6	61.6	11.7	71.0
9	106	5.6	21.7	9.6	38.6	11.3	51.1	12.6	54.9
10	131	4.5	17.2	7.9	32.3	9.7	44.1	11.4	57.1
11	127	4.7	18.6	7.7	32.0	8.9	43.2	8.4	54.9
12	134	4.4	18.3	6.8	32.1	7.9	42.9	8.4	56.4
13	119	5.0	21.0	7.9	35.5	7.4	45.4	7.2	58.2
14	160	3.7	17.5	6.3	28.6	7.6	36.7	7.2	48.0
15	191	3.1	18.9	5.0	30.6	6.2	39.6	9.9	59.0
16	189	3.2	20.4	5.3	34.4	6.9	44.8	12.3	55.3
17	151	3.9	17.6	7.3	30.6	9.2	39.6	12.3	58.2
18	139	4.3	17.5	7.3	30.6	7.6	40.3	8.4	51.3
19	135	4.4	16.1	8.0	30.2	9.6	44.4	12.9	57.1
20	144	4.1	14.9	7.2	25.9	8.1	34.9	9.9	51.3
21	95	6.2	17.5	10.2	31.0	10.0	42.3	10.2	75.1
22	116	5.1	14.4	8.8	27.9	9.6	37.5	8.4	45.0
23	98	5.9	13.8	9.8	25.1	10.8	35.1	11.7	41.7

STOP* 0

